Radiation-Utilizing Technology Overview

A survey of critical technologies utilizing radiation

and

How YOU will understand their functions after 22.01

Motivation for Today

- Answer two question in a few ways:
 - How can radiation be used to our benefit?
 - What is the physics behind how it is used?

Types of Technology

- Power Medical
- Space Semiconductors
- Product Development



Courtesy of City Labs, Inc. Used with permission.

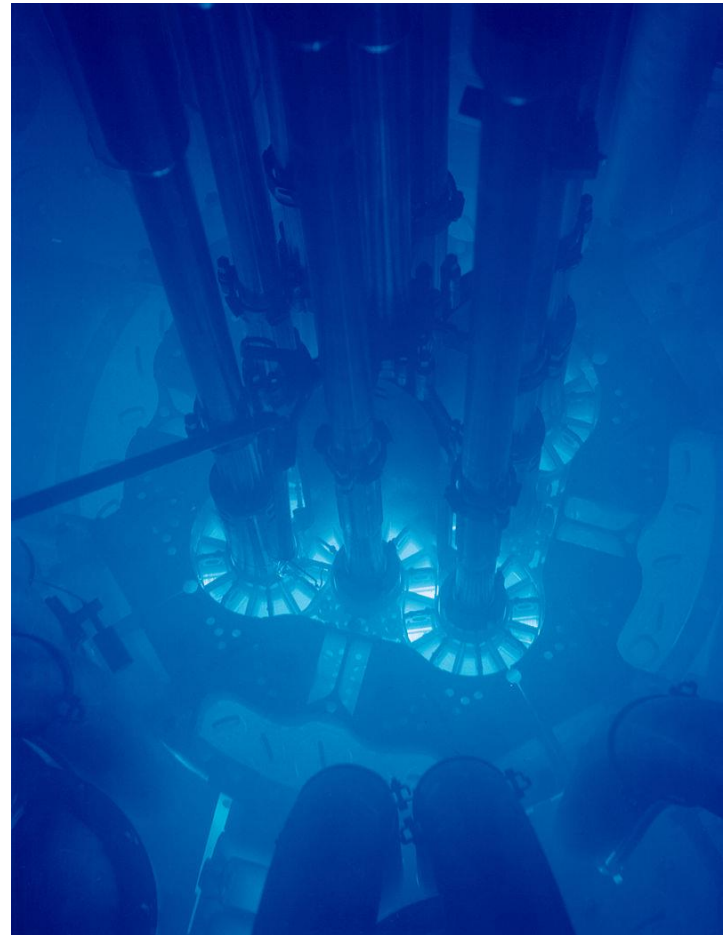

Courtesy of [Argonne National Laboratory](#) on Flickr. License CC BY-NC-SA.

Nuclear Power

http://www.nucleartourist.com/type/pwr_cycle.htm

- Overall reactor diagram

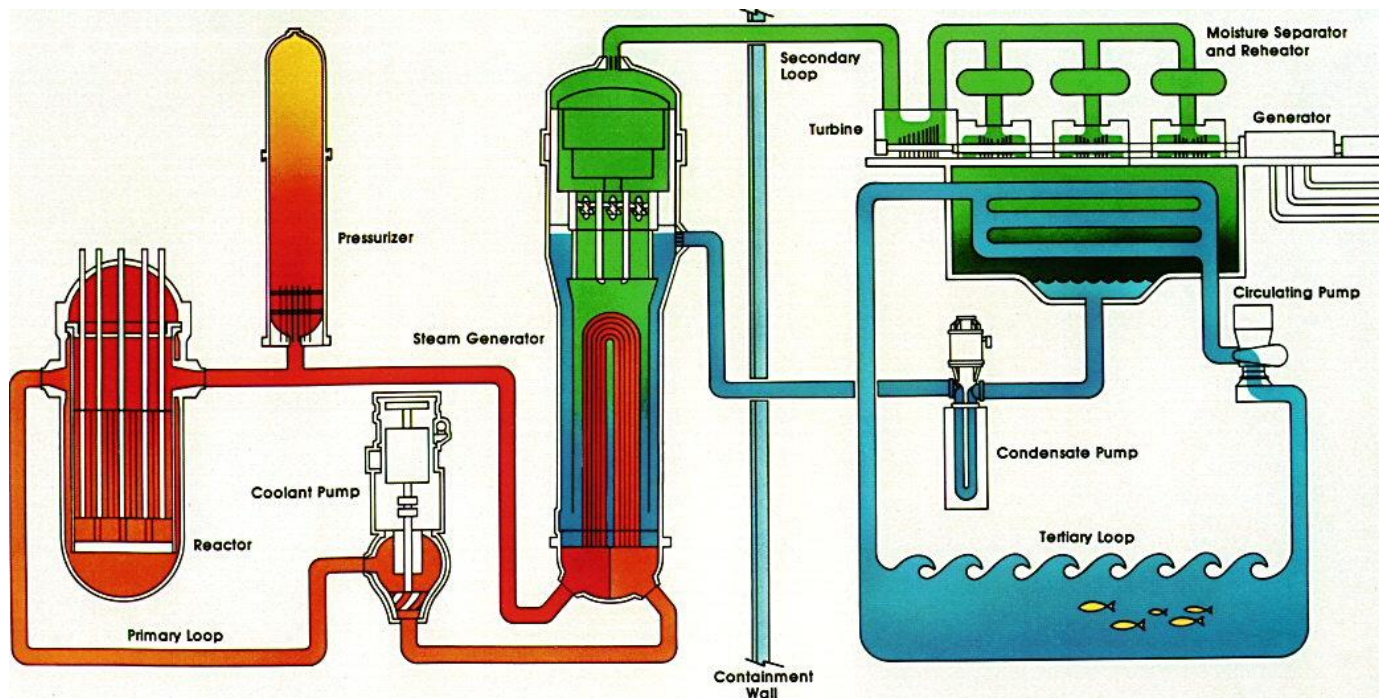

© Westinghouse. All rights reserved. This content is excluded from our Creative Commons license. For more information, see <http://ocw.mit.edu/help/faq-fair-use/>.



Nuclear Steam Supply System

MB 3618A

Nuclear Power

http://www.nucleartourist.com/type/pwr_cycle.htm

- Pressurized Water Reactor (PWR)

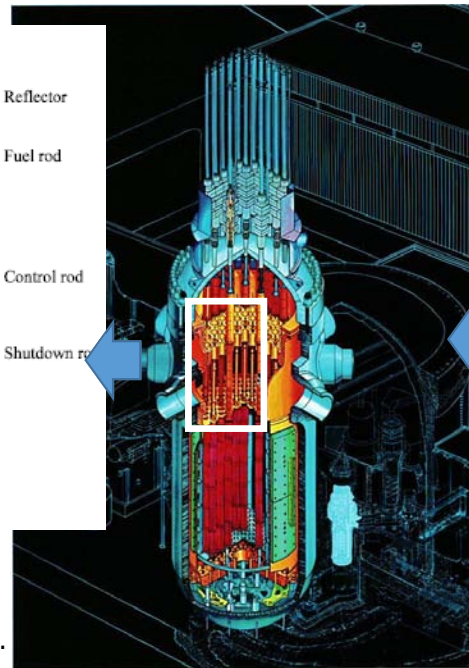
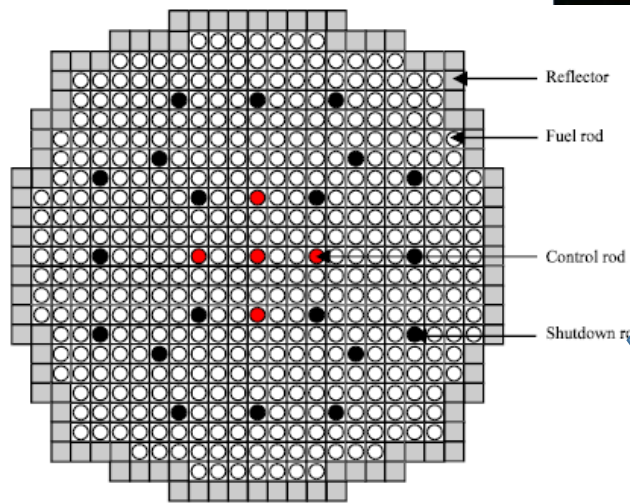

Westinghouse NUCLEAR REACTOR

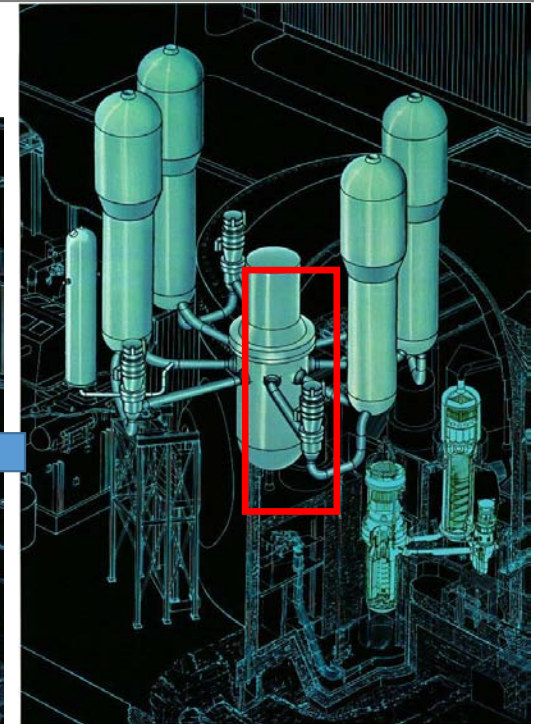

Westinghouse NUCLEAR STEAM SUPPLY SYSTEM

© Asian Network for Scientific Information. All rights reserved. This content is excluded from our Creative Commons license. For more information, see <http://ocw.mit.edu/help/faq-fair-use/>. Source: Hussain, A., and C. Xinrong. "Core Optimization Simulation for a Pressurized Water Reactor." Information Technology Journal 8, no. 2 (2009): 220-225. <http://dx.doi.org/10.3923/itj.2009.220.225>

© Westinghouse. All rights reserved. This content is excluded from our Creative Commons license. For more information, see <http://ocw.mit.edu/help/faq-fair-use/>.

How a Reactor Core Works

- Fuel, fission, and energetics
- Control rods
- Coolant and moderation
- Reflection and shielding

A Neat Aside

"Advanced Test Reactor" by Argonne National Laboratory

- Cherenkov Radiation
 - Beta particles traveling faster than the speed of light in *water*

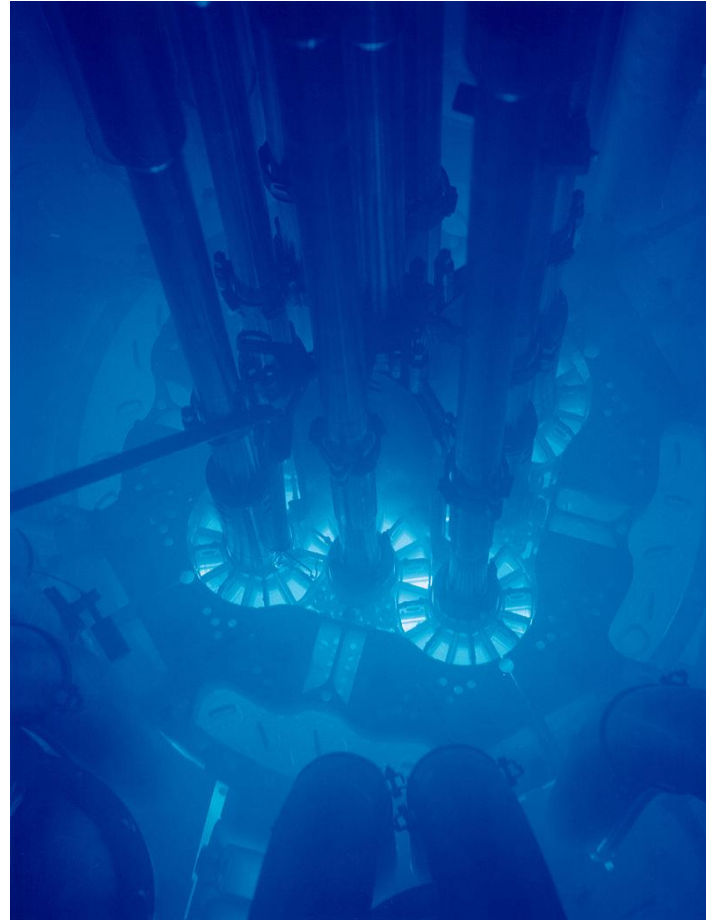

Courtesy of [Argonne National Laboratory](#) on Flickr. License CC BY-NC-SA.

Fusion Energy

<http://www.iter.org/>

- Fuse light nuclei ($D + D$ or $D + T$) instead

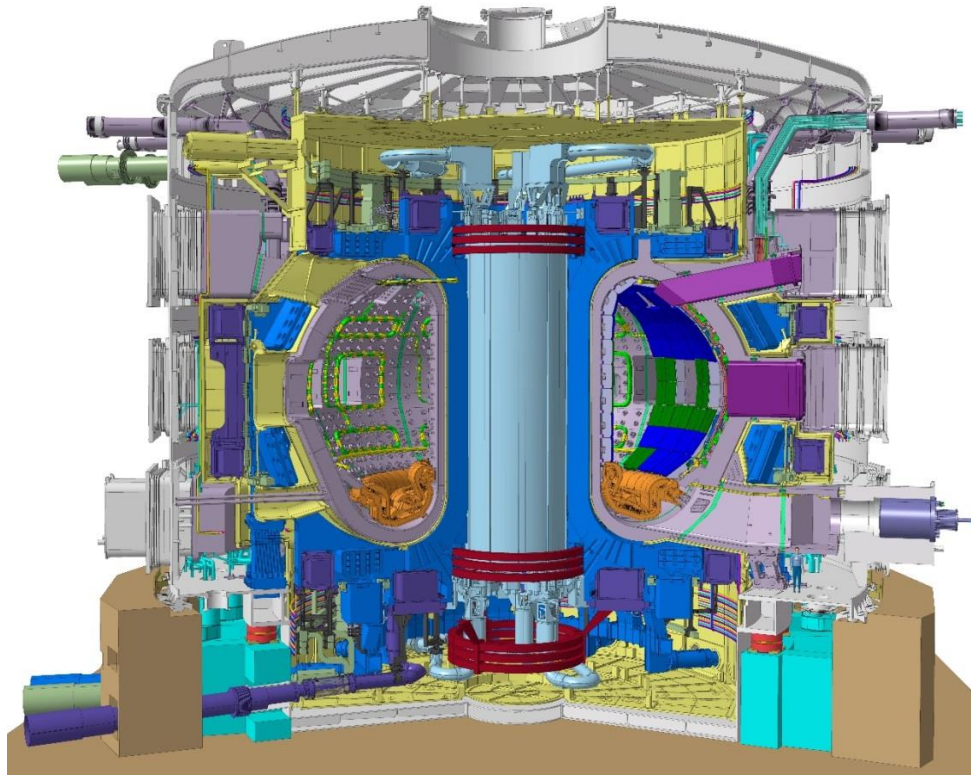

© ITER Organization. All rights reserved. This content is excluded from our Creative Commons license. For more information, see <http://ocw.mit.edu/help/faq-fair-use/>.

Fusion Reactor Workings

http://jolifukyu.tokai-sc.jaea.go.jp/fukyu/mirai-en/2006/3_12.html

- Fuse light nuclei, breed fuel from ${}^7\text{Li}$

- Use Pb-17Li, enrich in ${}^7\text{Li}$

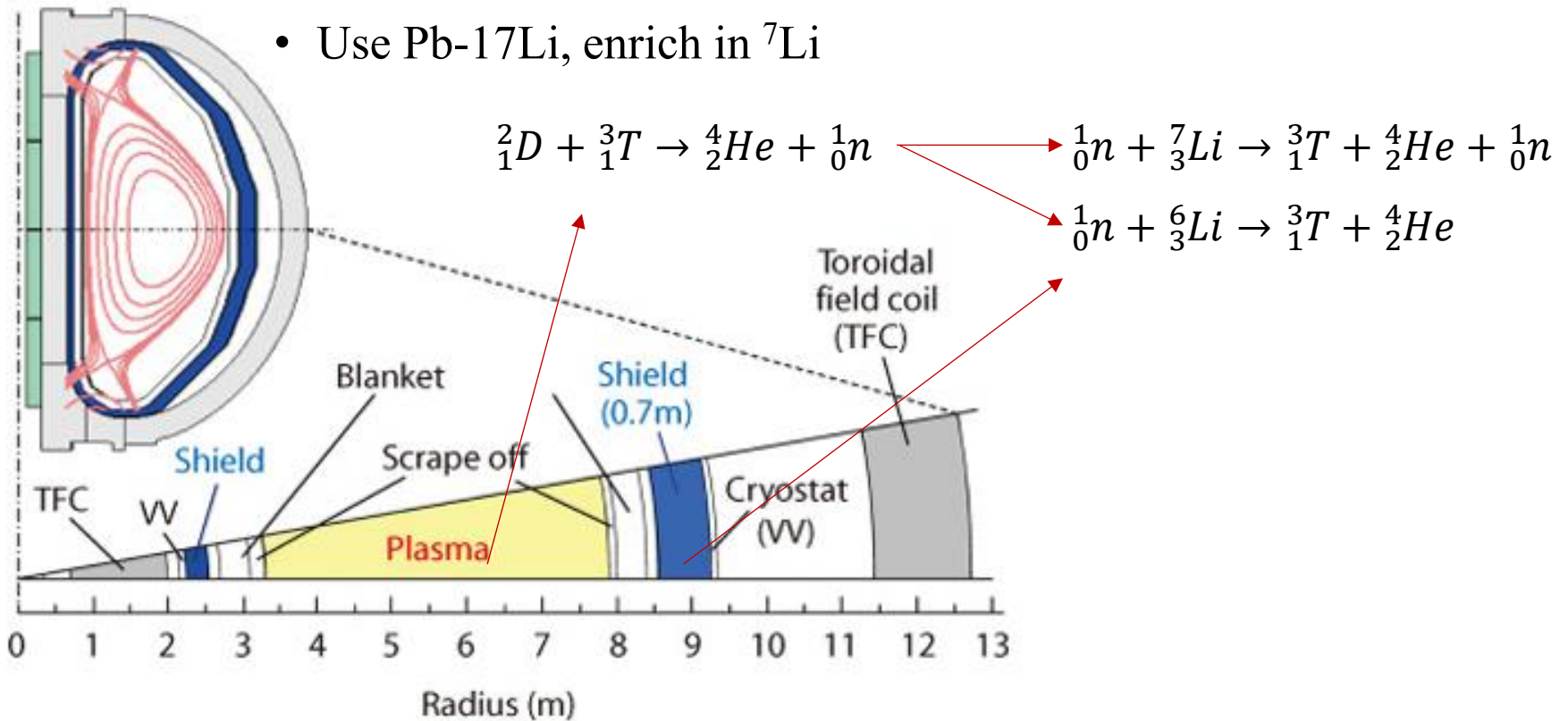

© Japan Atomic Energy Agency. All rights reserved. This content is excluded from our Creative Commons license. For more information, see <http://ocw.mit.edu/help/faq-fair-use/>.

Why Fission and Fusion Work

https://en.wikipedia.org/wiki/Nuclear_binding_energy

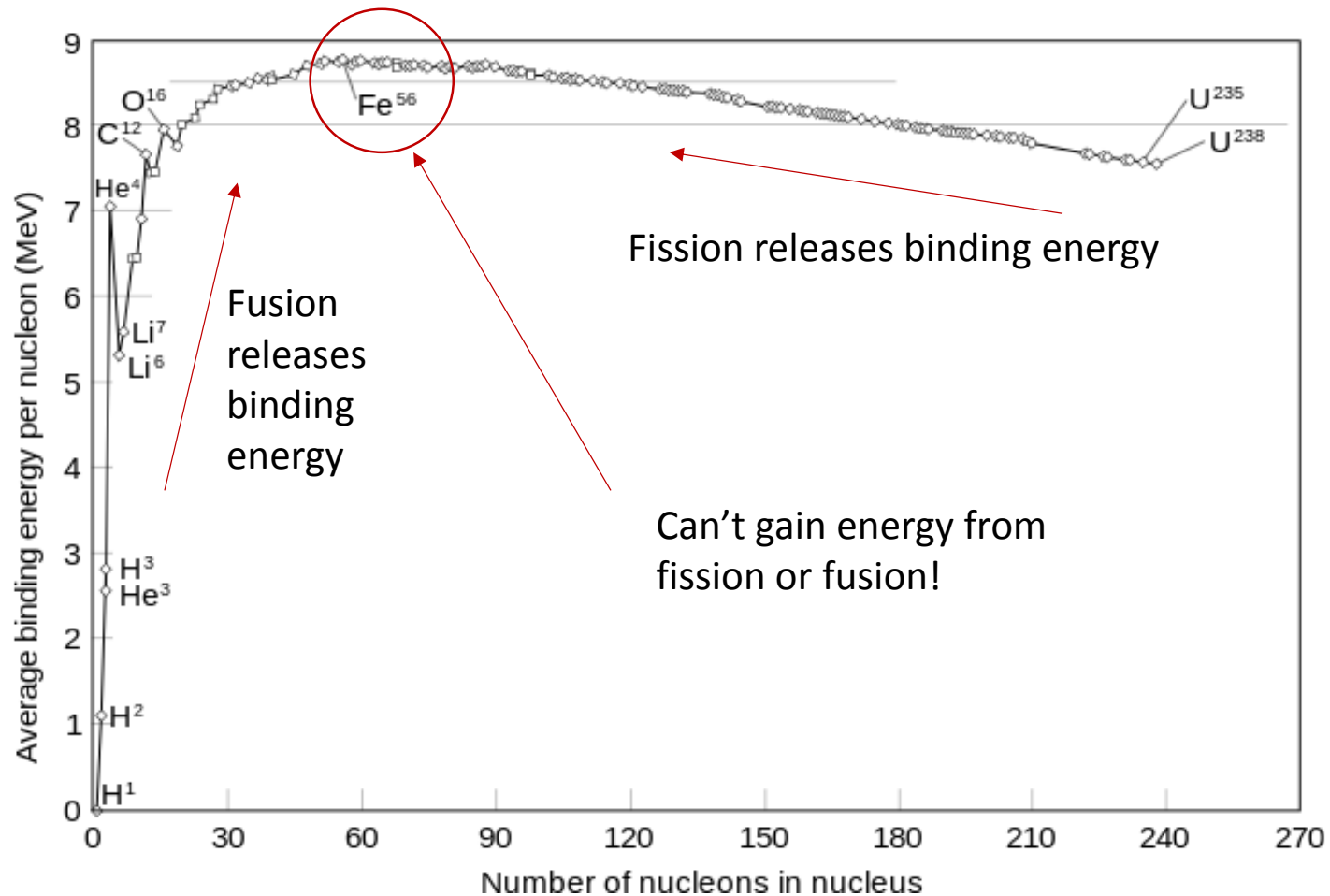

Public domain image.

Medical Uses of Radiation

- Imaging
- X-ray therapy
- Proton therapy
- Brachytherapy
- Radiotracers

Imaging

- Differential absorption (attenuation) of x-rays



Imaging

- Differential absorption (attenuation) of x-rays

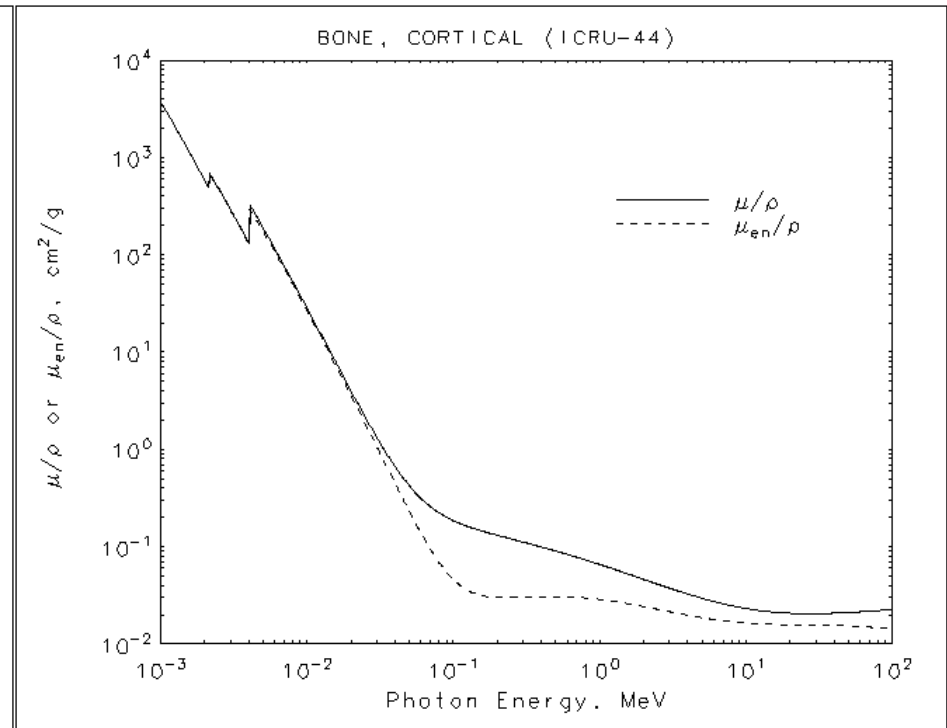
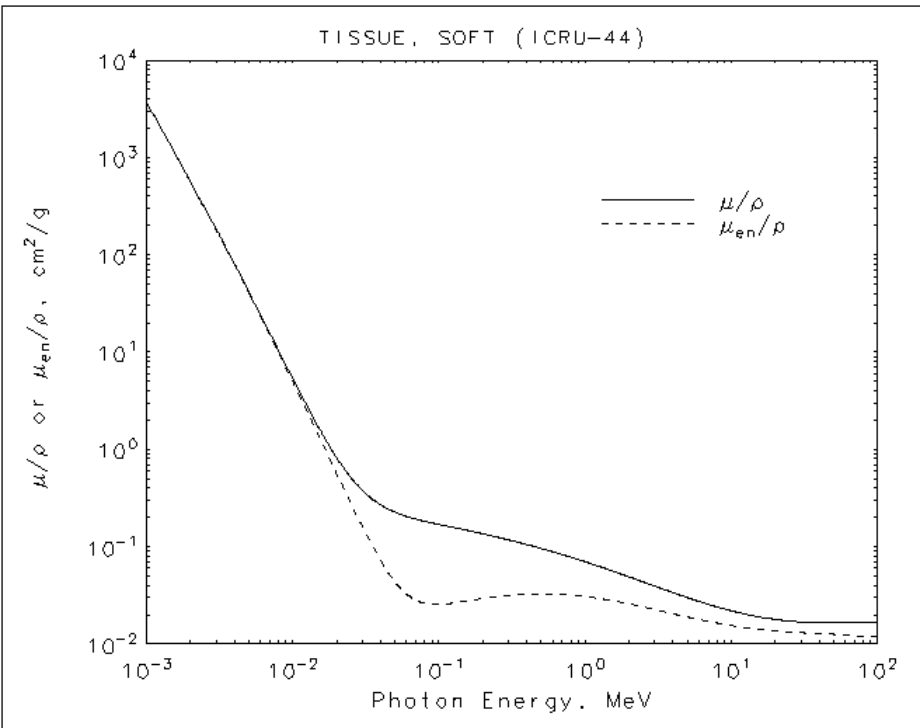

First x-ray taken by C. Roentgen



Courtesy of [Porcaro Family](#) on Flickr. License CC BY-NC-SA.

Public domain, from U.S. NIST.

X-Ray Therapy

- Hinges upon absorption of x-rays by tumors

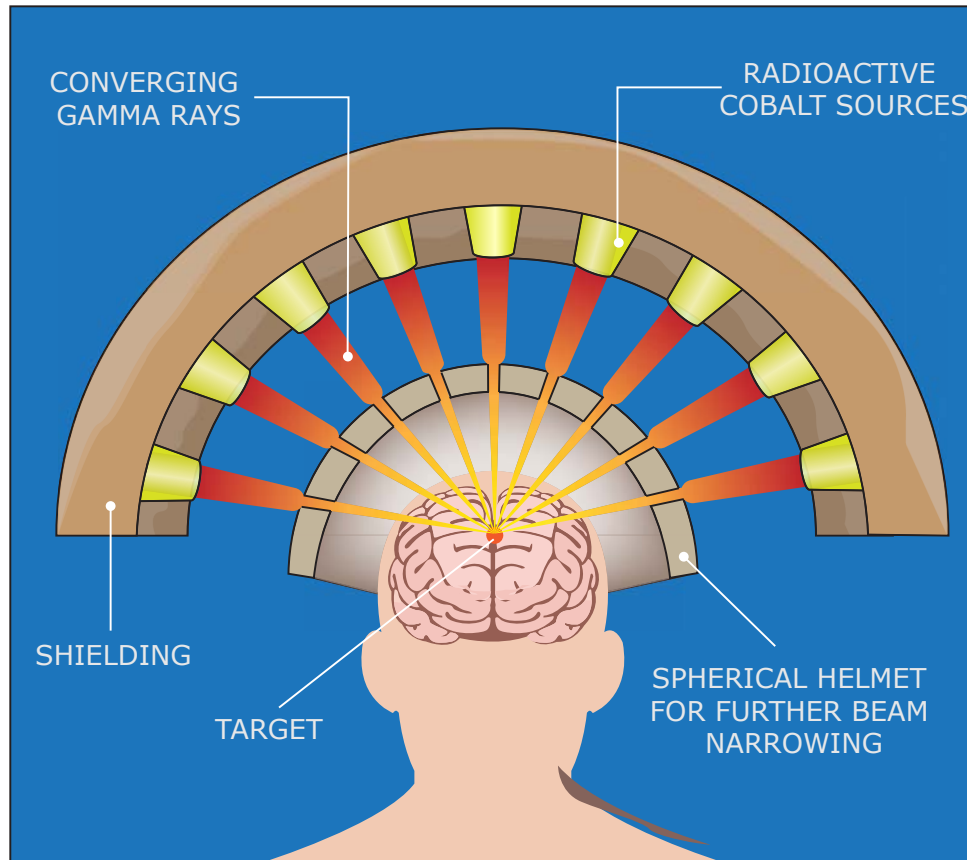
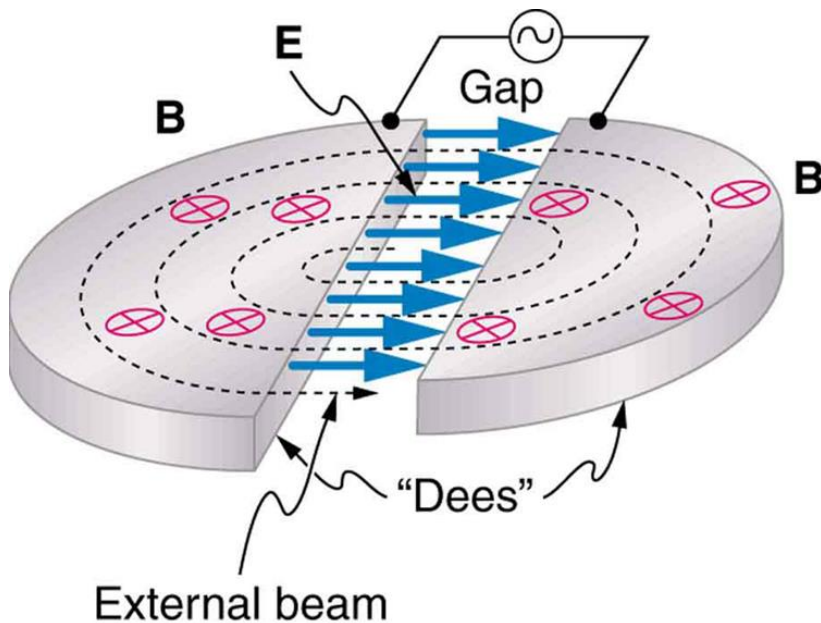

Image by MIT OpenCourseWare.

Proton Therapy

- Use an accelerator (cyclotron) to accelerate protons, fire them into the tumor!



Courtesy of Vietnam Open Educational Resources. License CC BY.

<http://voer.edu.vn/m/accelerators-create-matter-from-energy/389d856b>

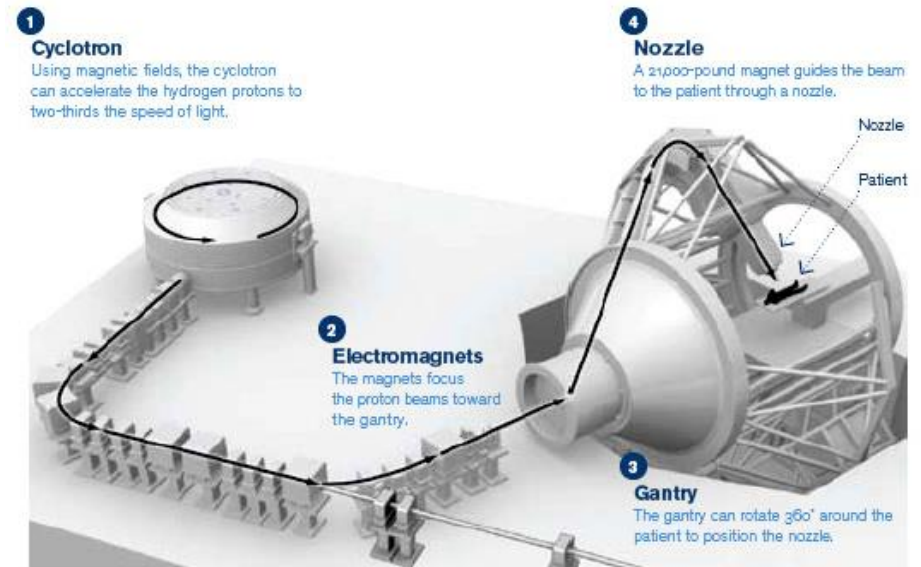

© The New York Times. All rights reserved. This content is excluded from our Creative Commons license. For more information, see <http://ocw.mit.edu/help/faq-fair-use/>.

See <http://www.symmetrymagazine.org/article/december-2008/the-power-of-proton-therapy>

Why Protons vs. X-Rays?

- Highly controllable range vs. just attenuation

Run SRIM live as demo

Why Protons vs. X-Rays?

- Intensity Modulated Radiation Therapy (IMRT)

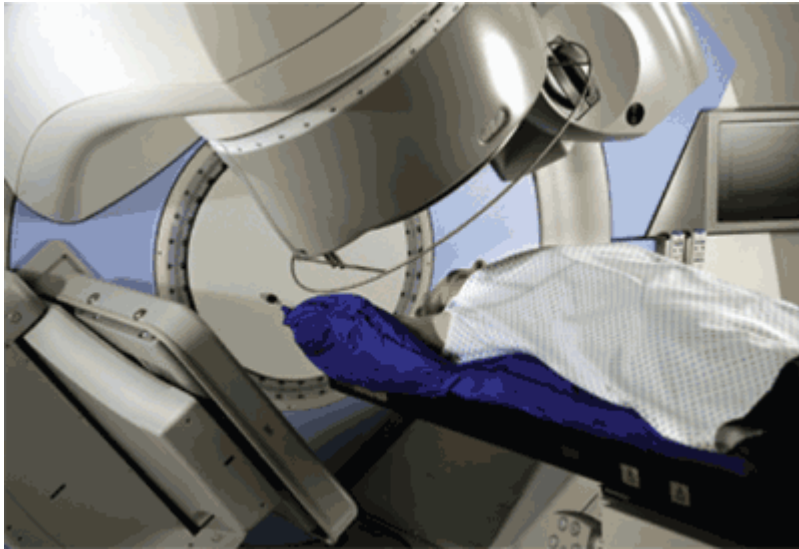

© American Academy of Family Physicians. All rights reserved. This content is excluded from our Creative Commons license. For more information, see <http://ocw.mit.edu/help/faq-fair-use/>.

<http://www.aafp.org/afp/2008/1201/p1254.html>

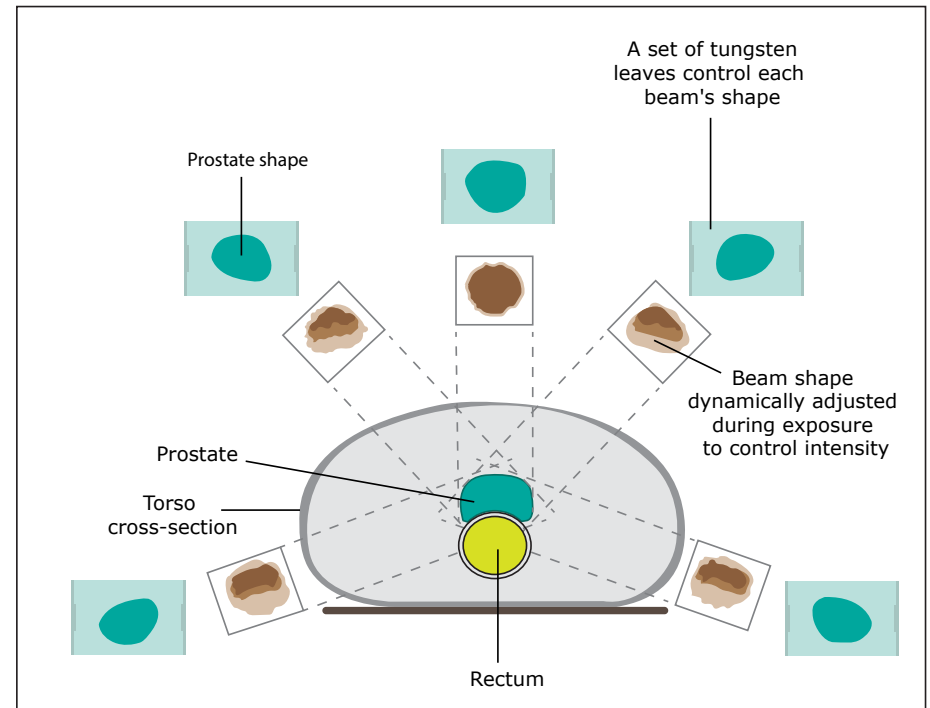
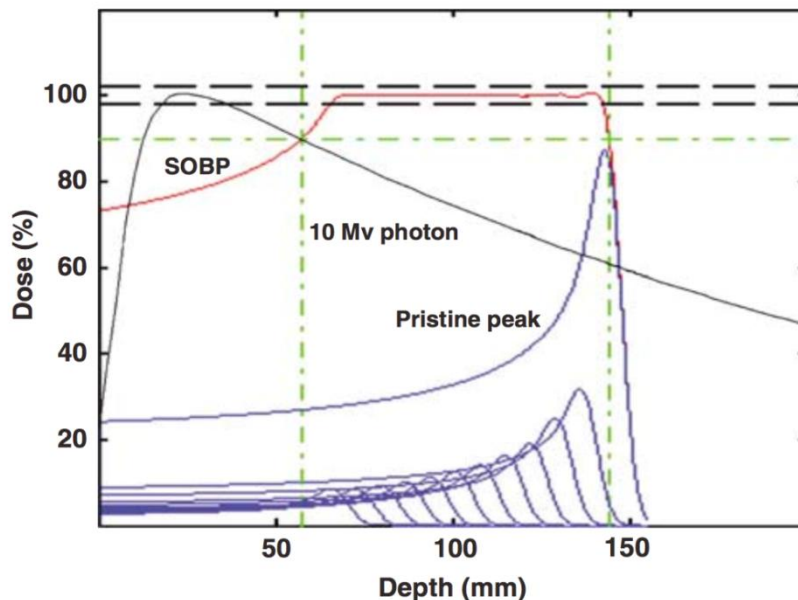

Image by MIT OpenCourseWare.

Why Protons vs. X-Rays?

- Intensity Modulated Radiation Therapy (IMRT)



Courtesy of Macmillan Publishers Ltd. License CC BY-NC-SA.
Source: W. P. Levin et al. "Proton beam therapy." *British J. Cancer*, 93(8):849-854 (2005).

W. P. Levin et al. "Proton beam therapy." *British J. Cancer*, 93(8):849-854 (2005).

Brachytherapy

<https://en.wikipedia.org/wiki/Brachytherapy>

- Relies on simple radioactive decay
 - Implanted directly into tumor



Brachytherapy “seeds”

Public domain photo.

- Ir-192 commonly used
- Short or long range?
- Short or long half life?
- Biocompatibility?

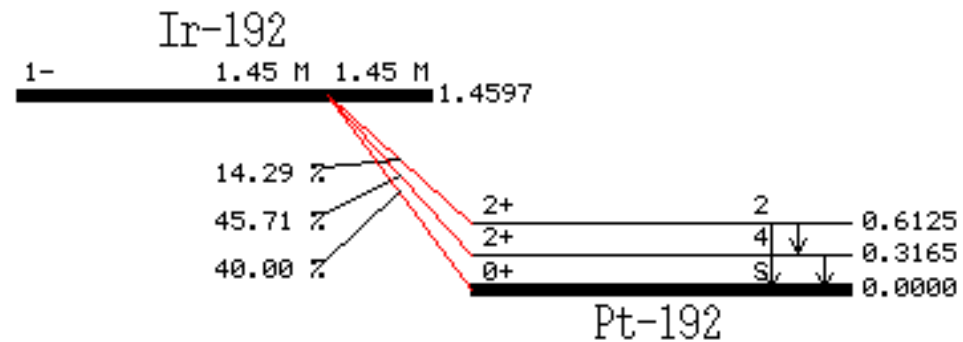

Courtesy of Korea Atomic Energy Research Institute. Used with permission.

Radiotracers

- Typically $^{99}\text{Mo} \rightarrow ^{99\text{m}}\text{Tc}$, attached to other chemicals for imaging procedures

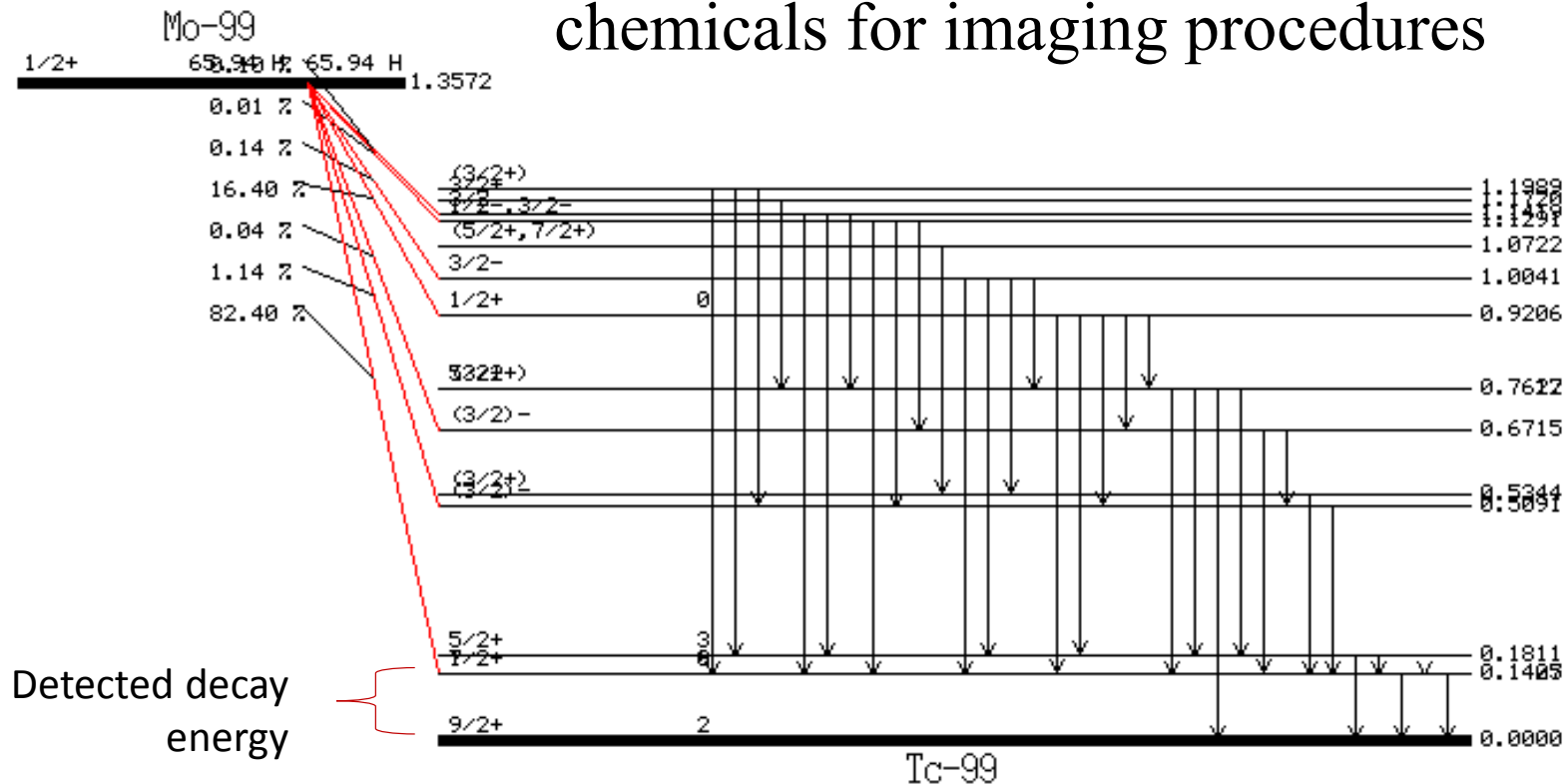

Courtesy of Korea Atomic Energy Research Institute. Used with permission.

Radiotracers

<http://www.ghorayeb.com/ParathyroidSestamibisSPECT.html>

- Typically $^{99}\text{Mo} \rightarrow ^{99\text{m}}\text{Tc}$, attached to other chemicals for imaging procedures

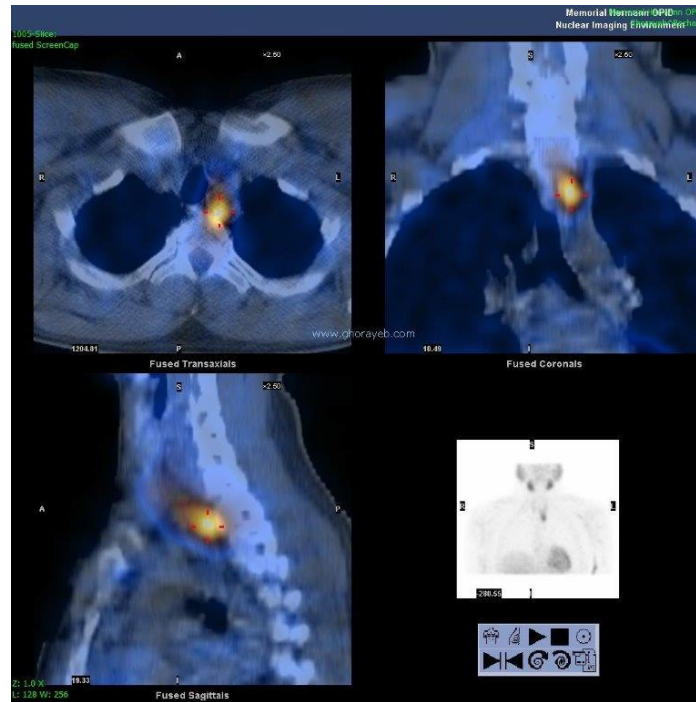

Courtesy of Bechara Y. Ghorayeb, MD. Used with permission.

HUGE ^{99}Mo Shortages!

Nature 460, 312-313 (2009), doi:10.1038/460312a



Reprinted by permission of Macmillan Publishers Ltd.
Source: Gould, Paula. "[Medical isotope shortage reaches crisis level.](#)" *Nature* 460, 312-313 (2009).

Soon, highly enriched targets will be illegal...

Space Applications

- Astronaut Shielding
- Radioisotope Thermoelectric Generators (RTGs)
- Nuclear Rockets

Shielding

- Must know basic principles of shielding vs.
 - Density
 - Material
 - Energy

https://commons.wikimedia.org/wiki/File:Alfa_beta_gamma_radiation_penetration.svg

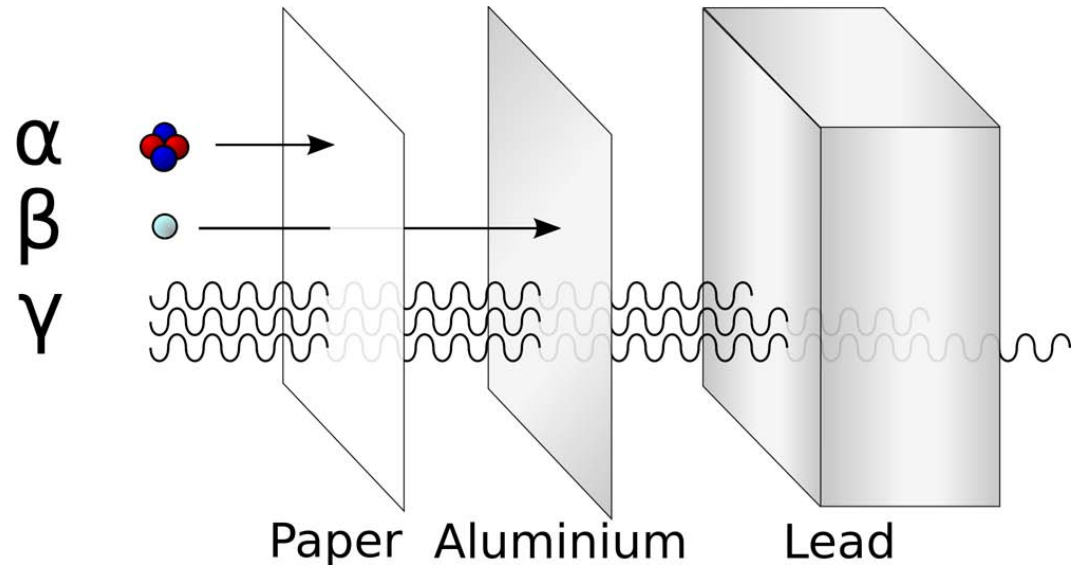

Courtesy of Wikipedia User: Stannered. License CC BY.

More Complex Shielding

http://www.nasa.gov/offices/oct/early_stage_innovation/niac/westover_radiation_protection.html

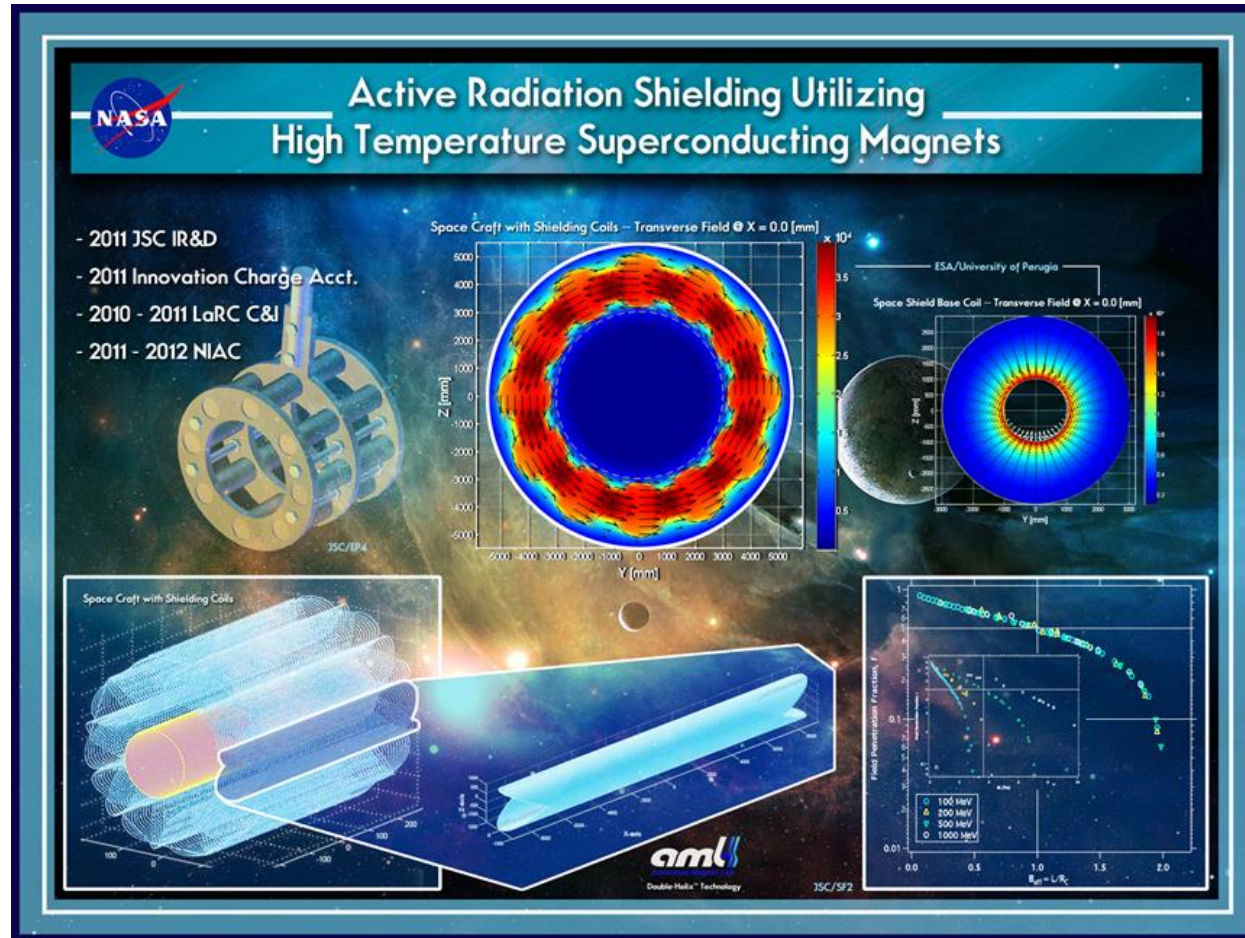

Public domain image.

RTGs

- Long-lived, high power decay heat sources

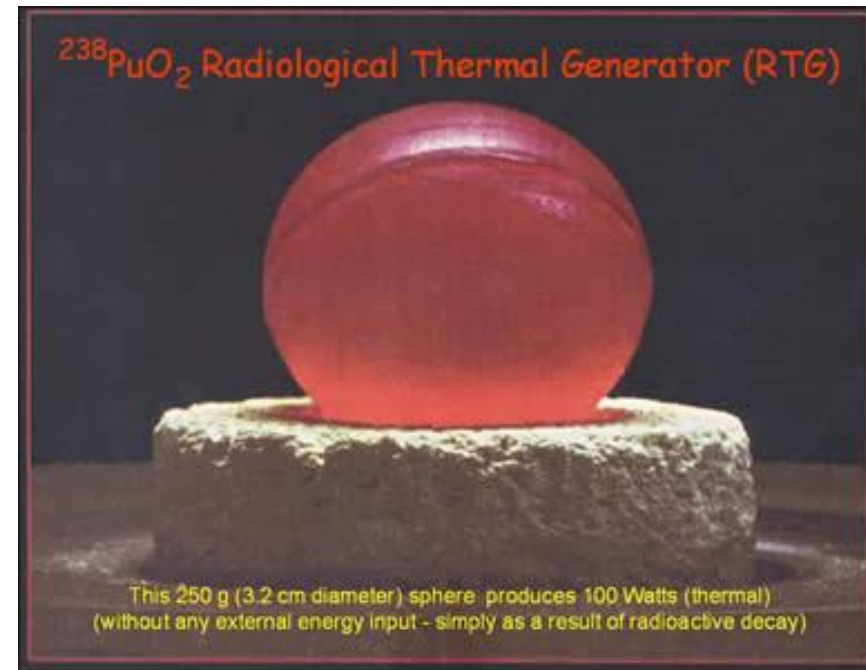
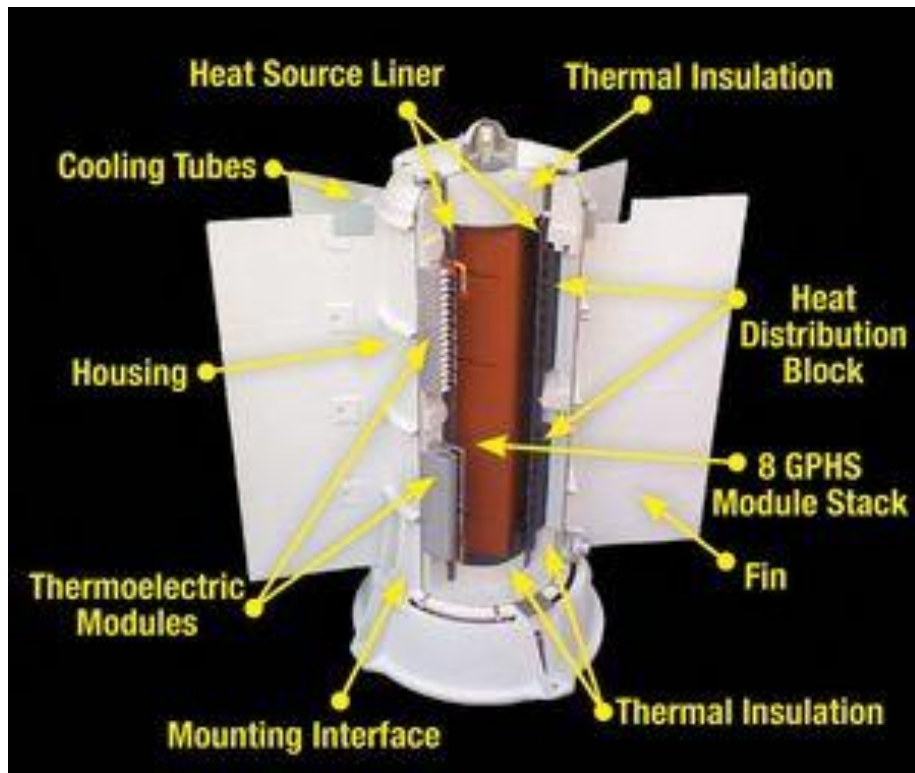

Public domain image.

<https://radio.chem.wsu.edu/why/>

http://solarsystem.nasa.gov/rps/docs/MMRTGfactsFeb_2010.pdf

Nuclear Rockets

<http://motherboard.vice.com/blog/should-we-worry-about-a-nuclear-future-in-space>

- Thrust may be lower, but life is longer!

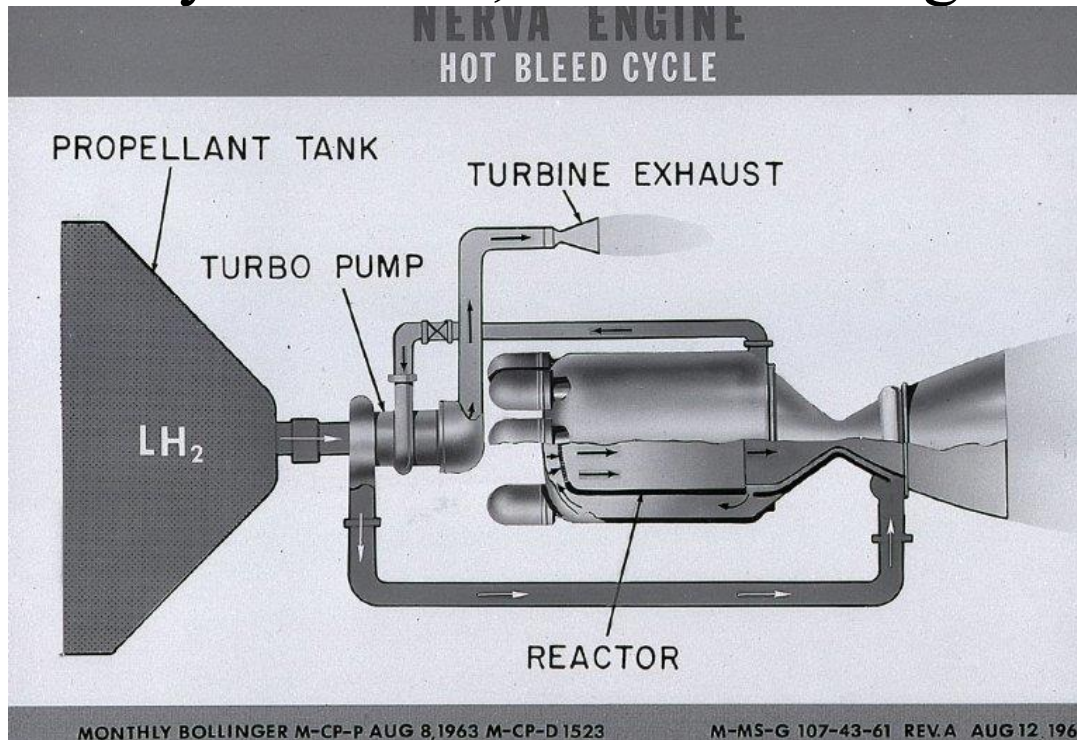

Public domain image.

<http://trajectory.grc.nasa.gov/projects/ntp/>

Semiconductor Processing

<http://nrl.mit.edu/facilities/ntds>

- VERY precise n-type doping of Si to P

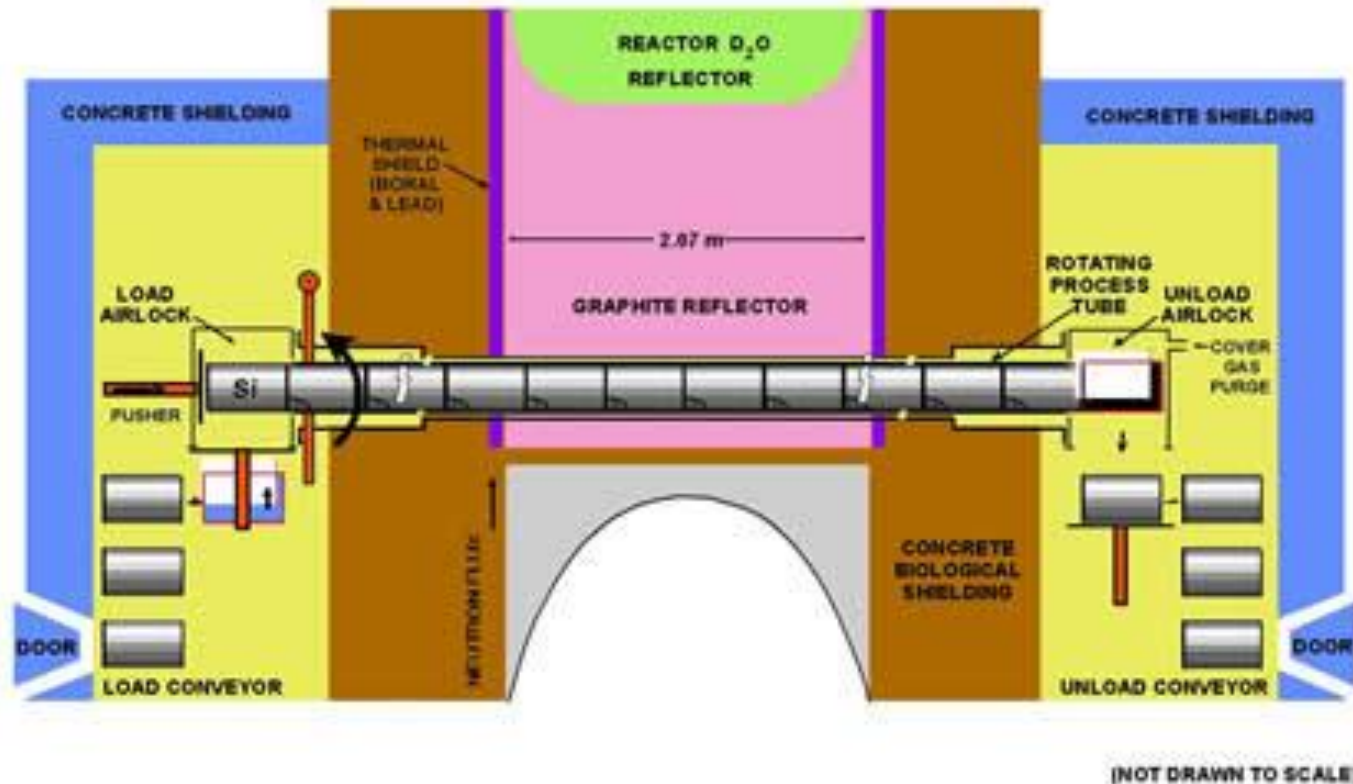

Courtesy of MIT Nuclear Reactor Laboratory. Used with permission.

Accelerator Applications

see animation at <http://www.businessinsider.com/how-sapphire-glass-screens-are-made-2014-9>

- Making super thin, scratch-proof iPhone screens

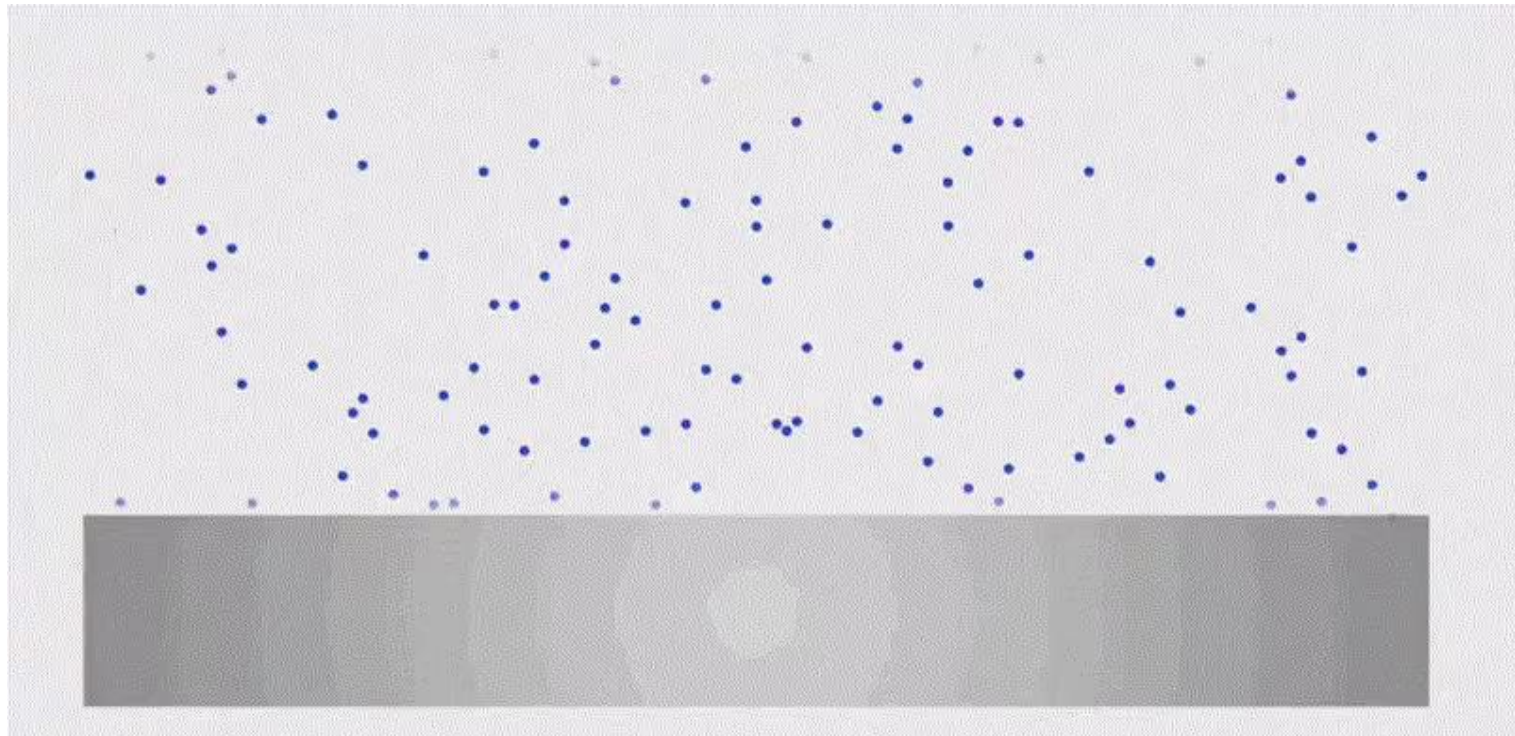

Courtesy of Neutron Therapeutics, Inc. Used with permission.

Accelerator Applications

see animation at <http://www.businessinsider.com/how-sapphire-glass-screens-are-made-2014-9>

- Making super thin, scratch-proof iPhone screens

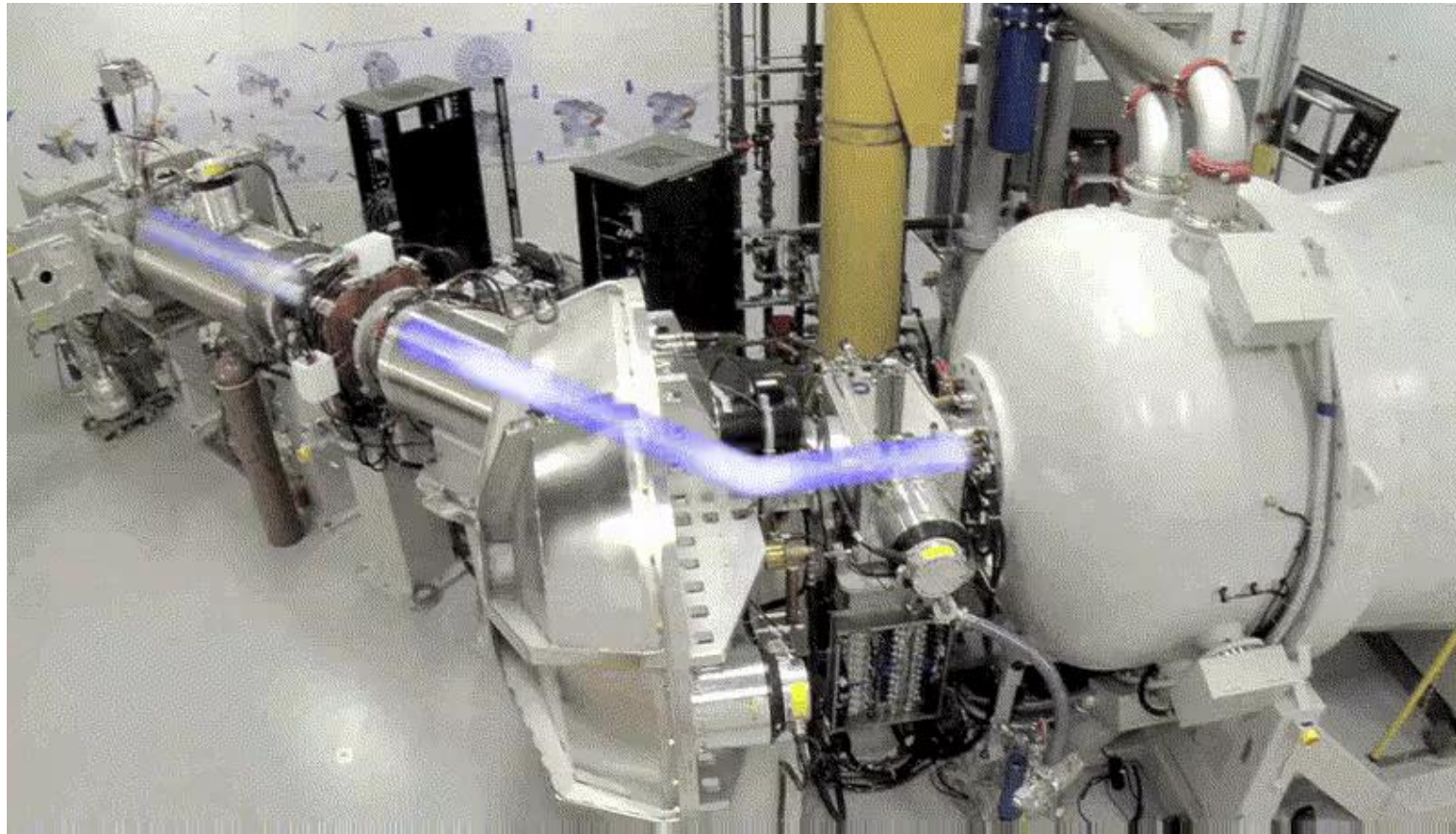

Courtesy of Neutron Therapeutics, Inc. Used with permission.

Accelerator Applications

see animation at <http://www.businessinsider.com/how-sapphire-glass-screens-are-made-2014-9>

- Making super thin, scratch-proof iPhone screens



Courtesy of Neutron Therapeutics, Inc. Used with permission.

Accelerator Applications

see animation at <http://www.businessinsider.com/how-sapphire-glass-screens-are-made-2014-9>

- Making super thin, scratch-proof iPhone screens

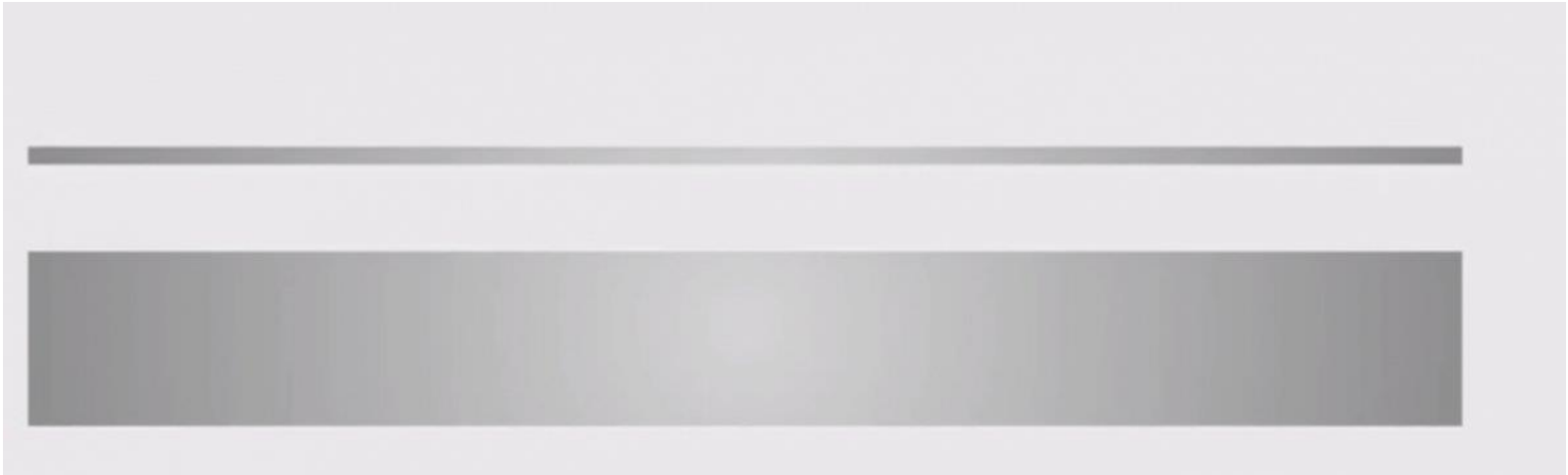

Courtesy of Neutron Therapeutics, Inc. Used with permission.

Other Products

<http://www.citylabs.net/>

- Betavoltaics – direct usage of *beta particle charge*
 - Semiconductor band gap accelerates electron-hole pairs

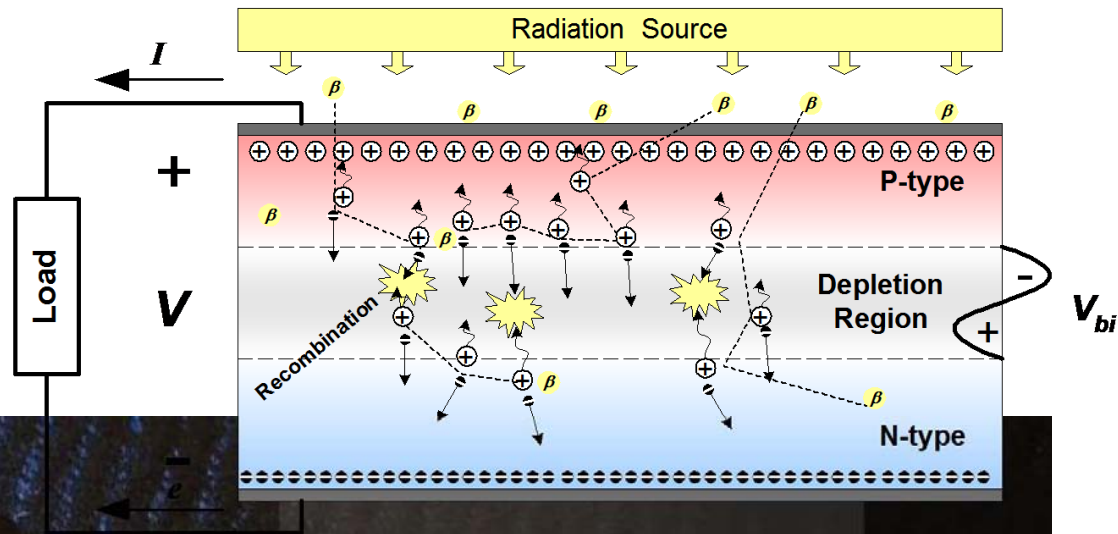

NanoTritium™ battery technology is scalable.

Courtesy of City Labs, Inc. Used with permission.

Detectors

- Various kinds for different uses



BF₃ neutron detector –

Courtesy of ORAU Foundation. Used with permission.

<http://www.oraufoundation.org/ptp/collection/proportional%20counters/nucchicago205bf3.htm>

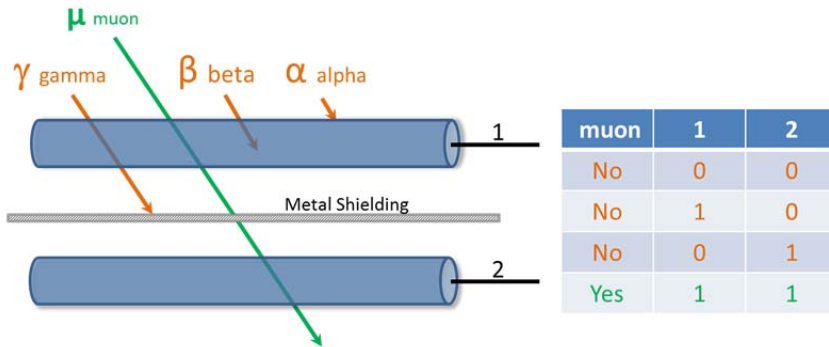

Courtesy of Robert Hart. Used with permission.

Two ionization tubes used as a muon coincidence detector - <https://hackaday.io/project/1700-cosmic-ray-muon-81-9x9-pixel-hodoscope>

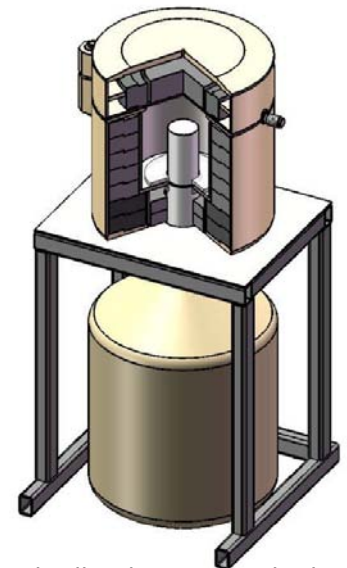

© STC RADEK Ltd. All rights reserved. This content is excluded from our Creative Commons license. For more information, see <http://ocw.mit.edu/help/faq-fair-use/>.

High-purity Ge gamma spectrometer - <http://www.radek.ru/en/product/Spectrometers-and-radiometers-of-radiation/49/>



© Libelium Comunicaciones Distribuidas S.L. All rights reserved. This content is excluded from our Creative Commons license. For more information, see <http://ocw.mit.edu/help/faq-fair-use/>.

Transparent Geiger tube – <https://www.cooking-hacks.com/documentation/tutorials/geiger-counter-radiation-sensor-board-arduino-raspberry-pi-tutorial/>

MIT OpenCourseWare
<http://ocw.mit.edu>

22.01 Introduction to Nuclear Engineering and Ionizing Radiation
Fall 2015

For information about citing these materials or our Terms of Use, visit: <http://ocw.mit.edu/terms>.