

# Hypercubic Networks

Charles E. Leiserson  
*6.895 Theory of Parallel Systems*  
November 2, 2003

1

## “Ideal” Parallel Computer

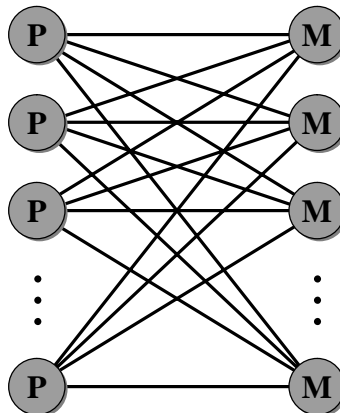

2

# “Ideal” Distributed-Memory Parallel Computer

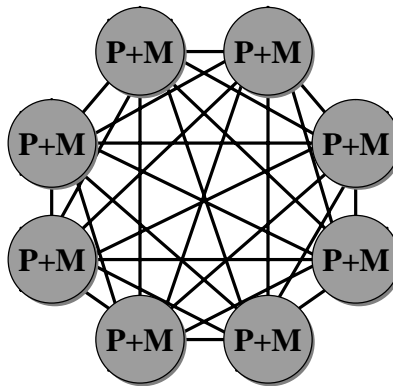

3

## Interconnection Networks

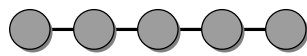

linear array

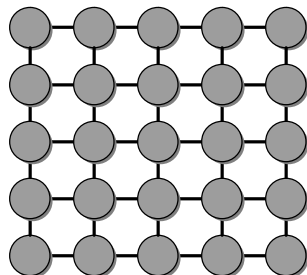

2D mesh

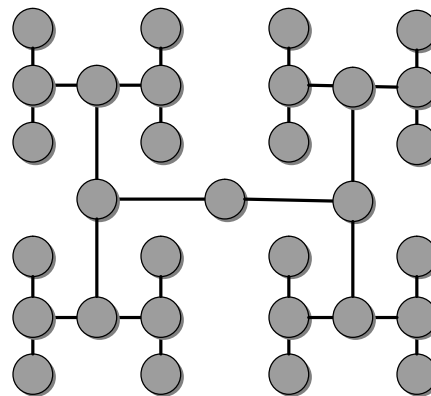

binary tree

4

# Hypercube

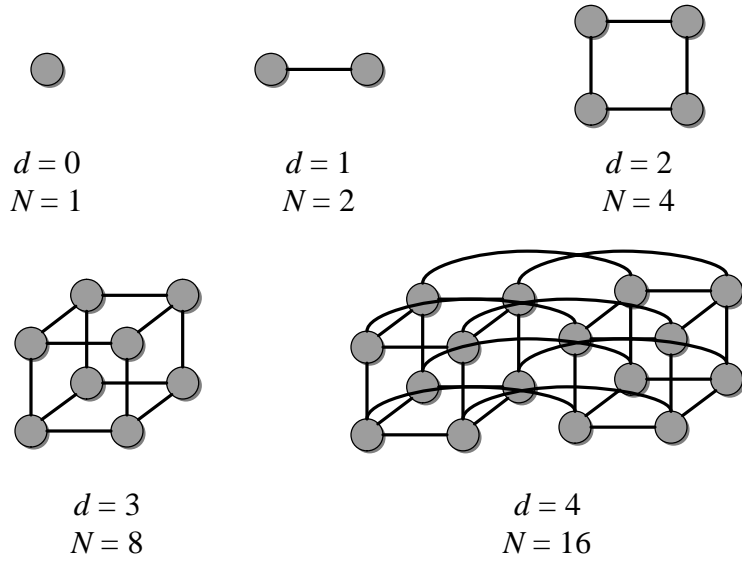

# Hypercube

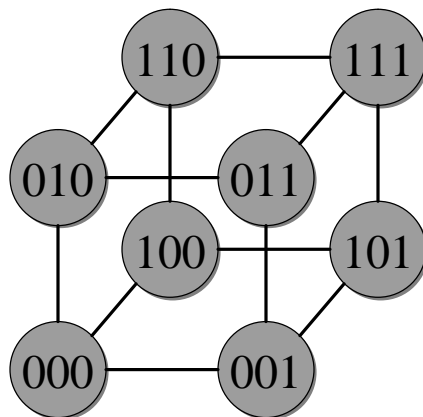

## Cube-Connected Cycles

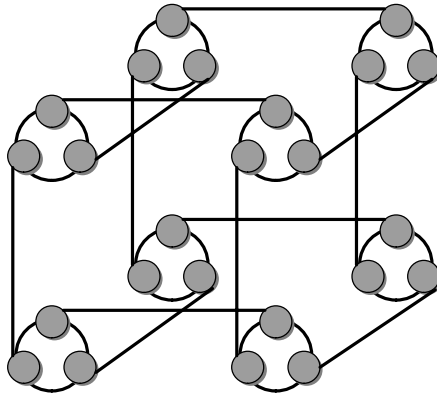

7

## Butterfly (FFT) Network

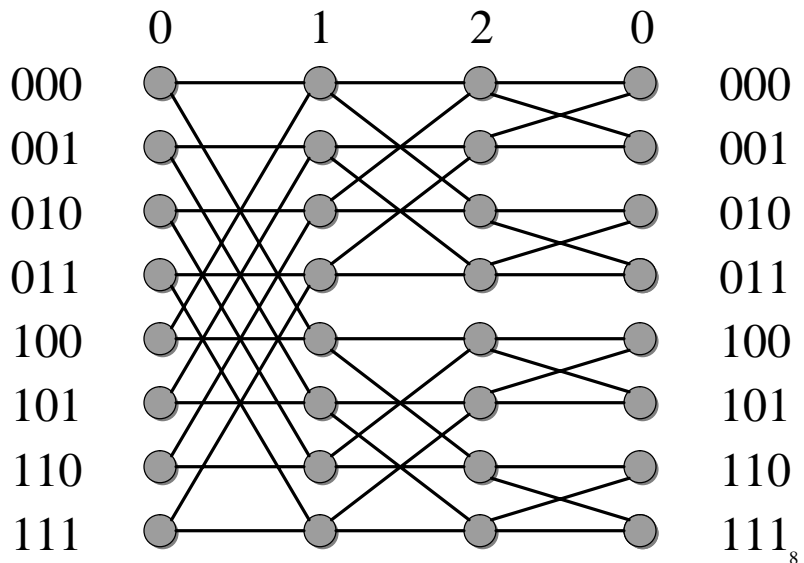

## Butterflies

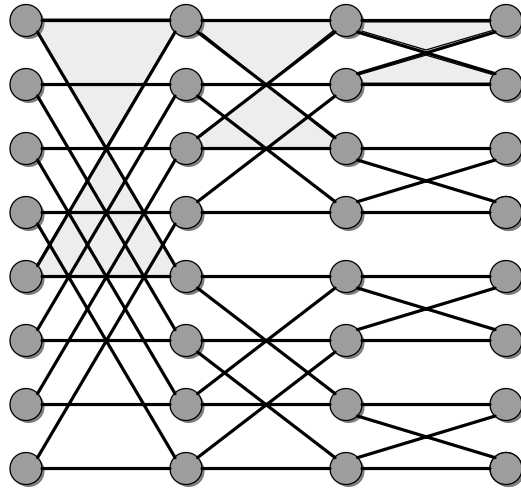

9

## Decomposing a Butterfly

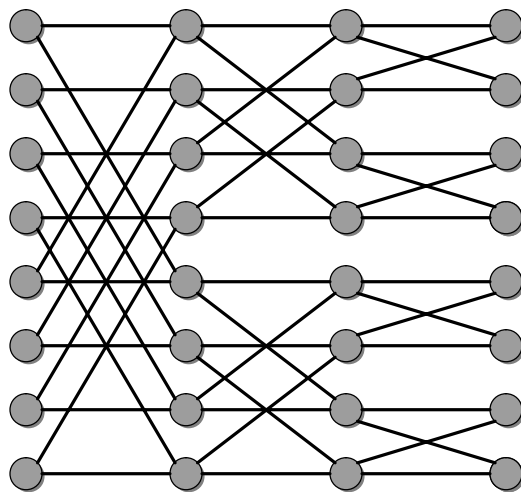

10

## Decomposing a Butterfly

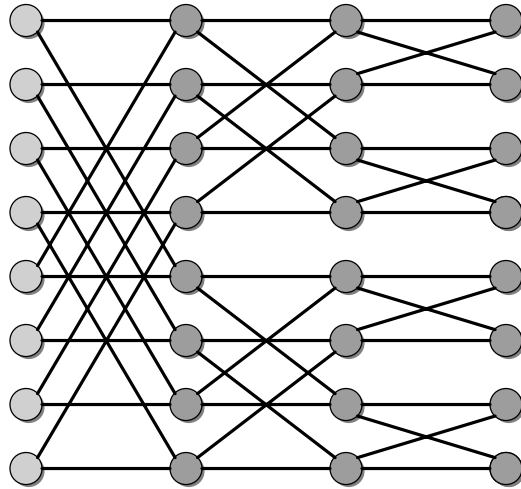

11

## Decomposing a Butterfly

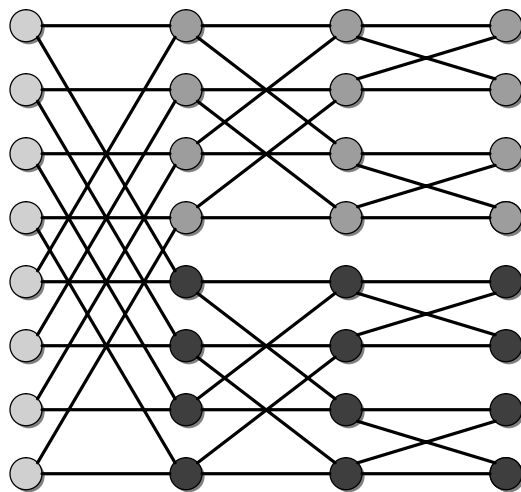

12

## Decomposing a Butterfly

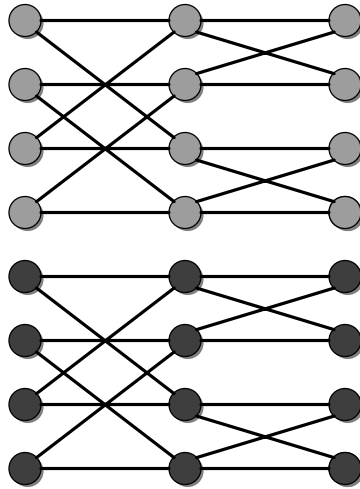

13

## Decomposing a Butterfly II

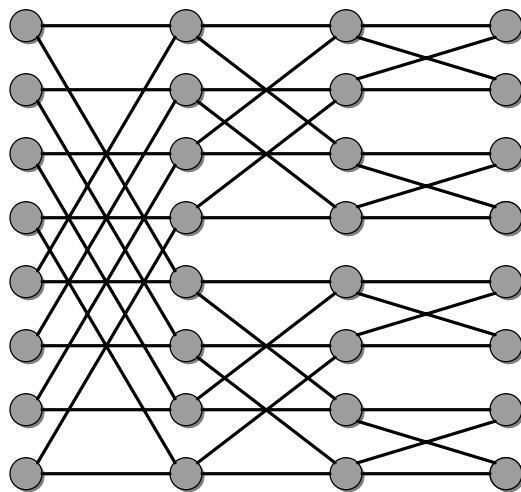

14

## Decomposing a Butterfly II

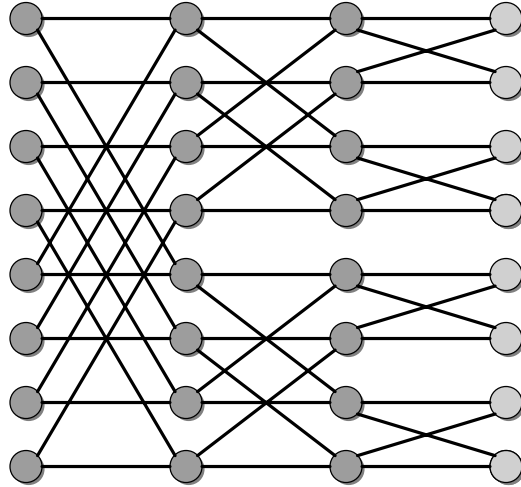

15

## Decomposing a Butterfly II

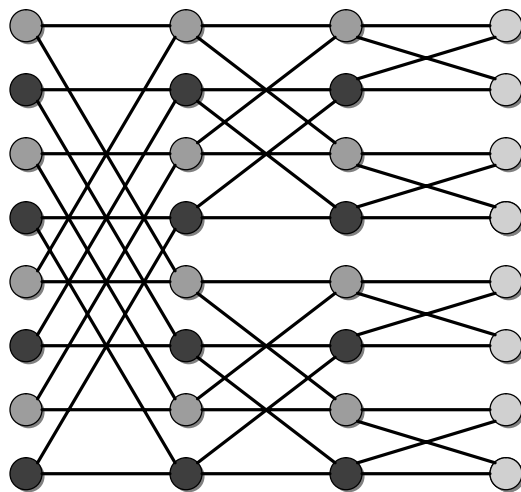

16



## Decomposing a Butterfly II

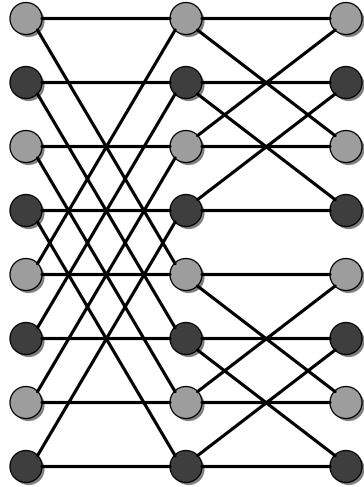

17

## Decomposing a Butterfly II

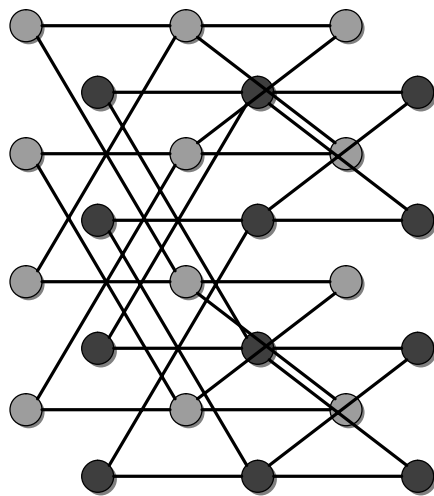

18

## Decomposing a Butterfly II

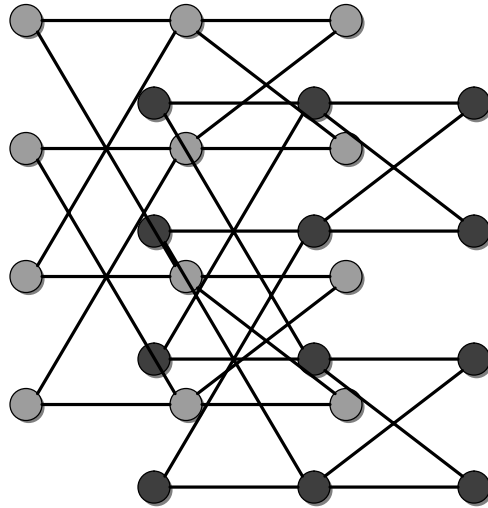

19

## Decomposing a Butterfly II

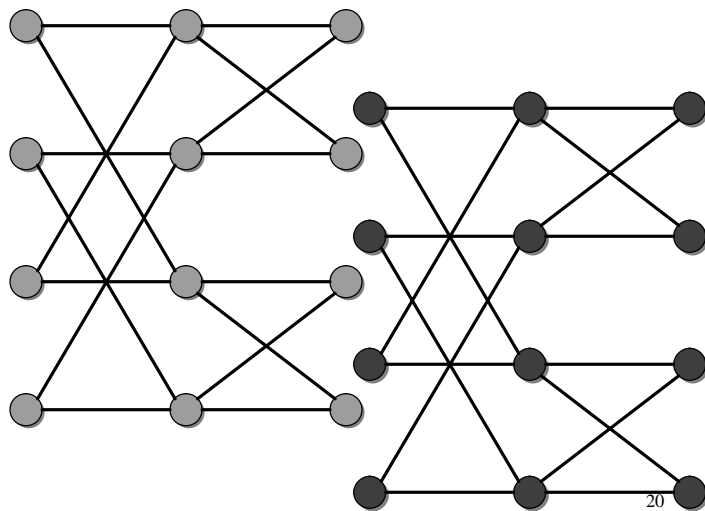

20

## Routing on a Butterfly

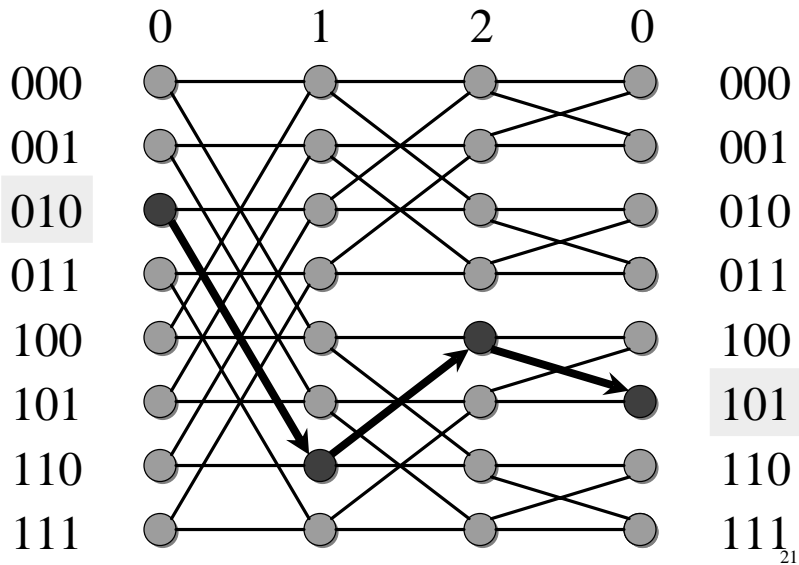

## Tree in Butterfly

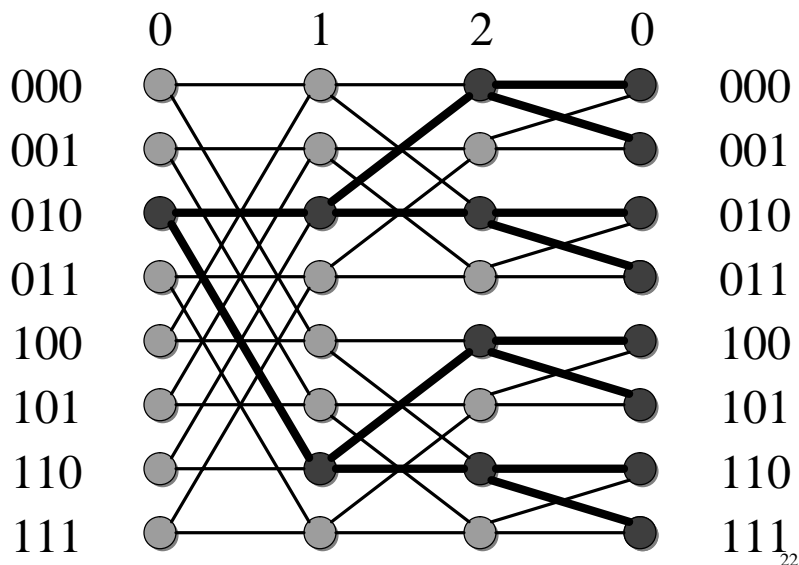

## Tree in Butterfly

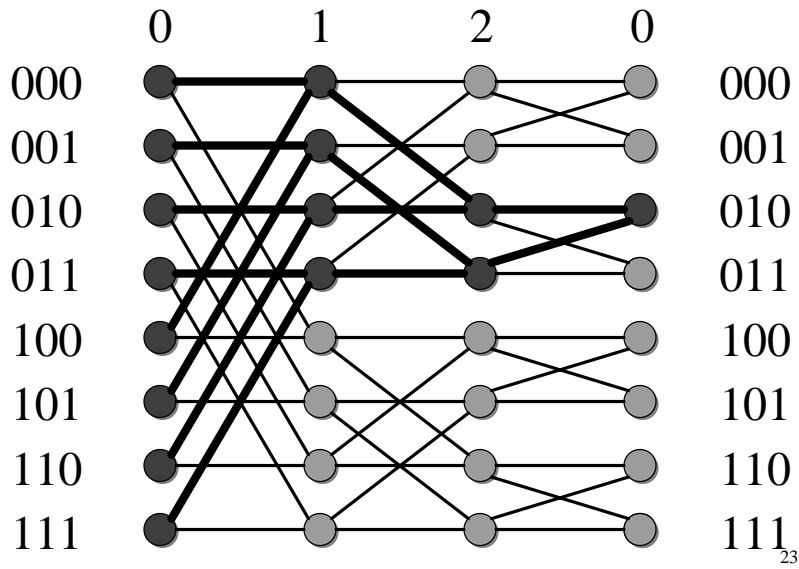

23

## Beneš Network

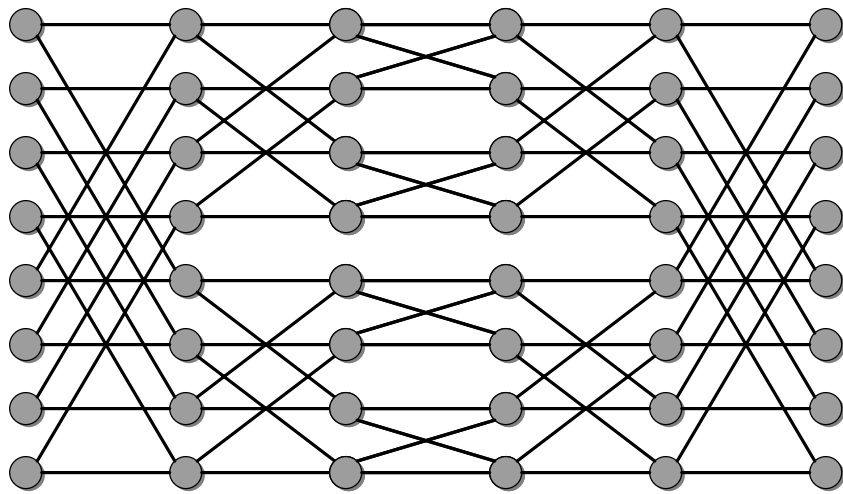

24

## Decomposing a Beneš Network

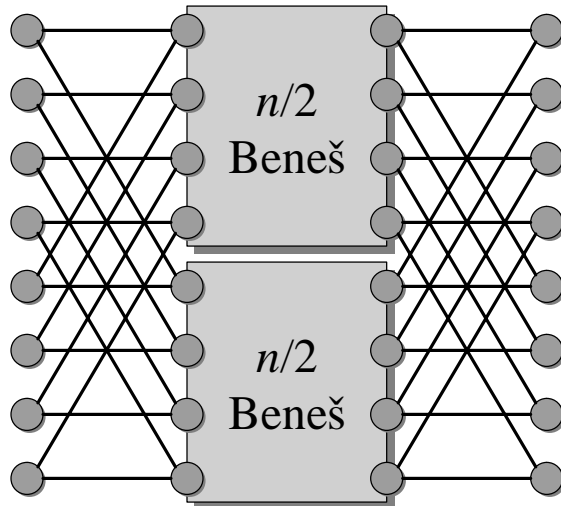

25

## Routing on a Beneš Network

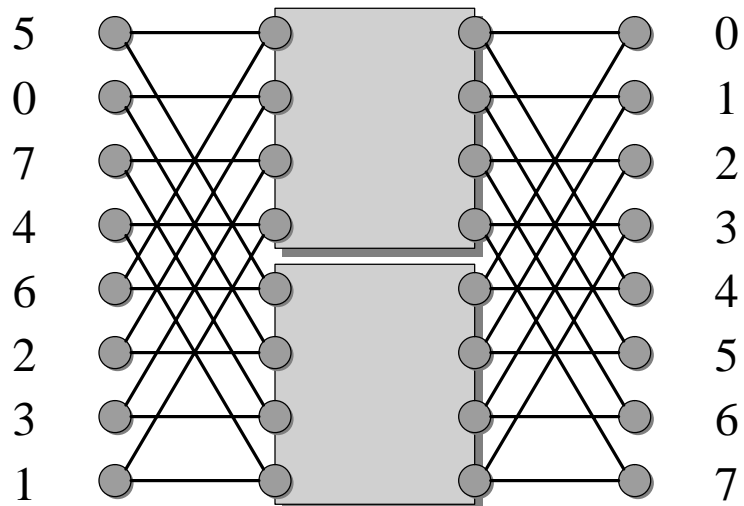

26

## Routing on a Beneš Network

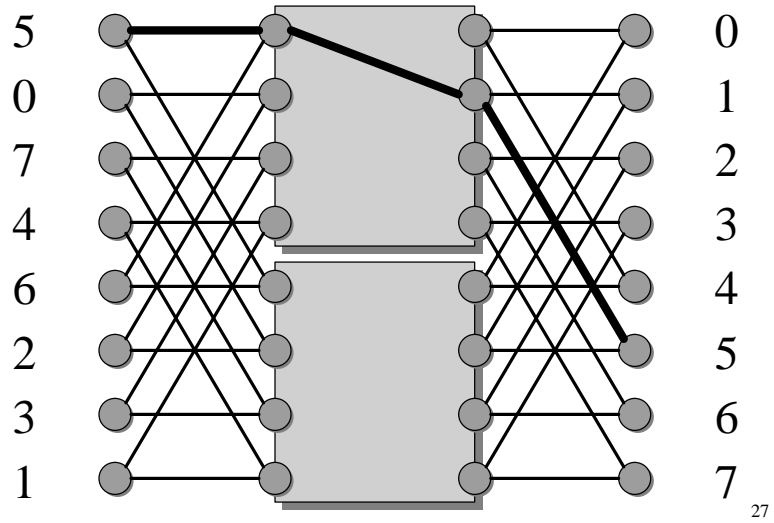

## Routing on a Beneš Network

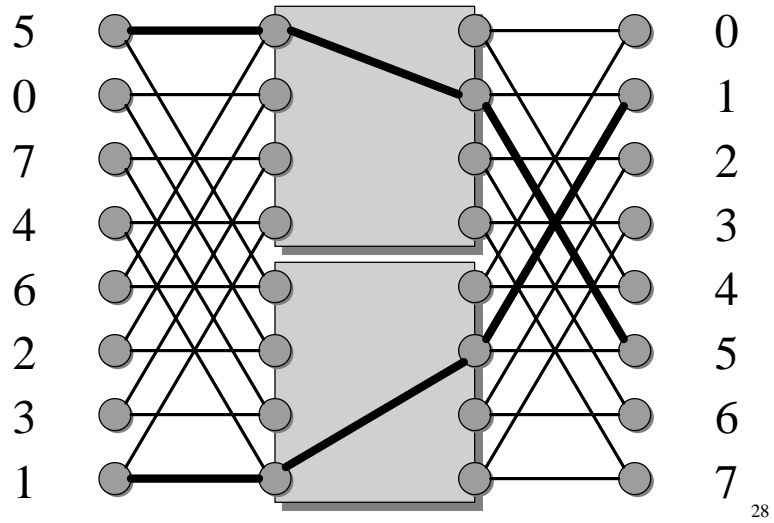

## Routing on a Beneš Network

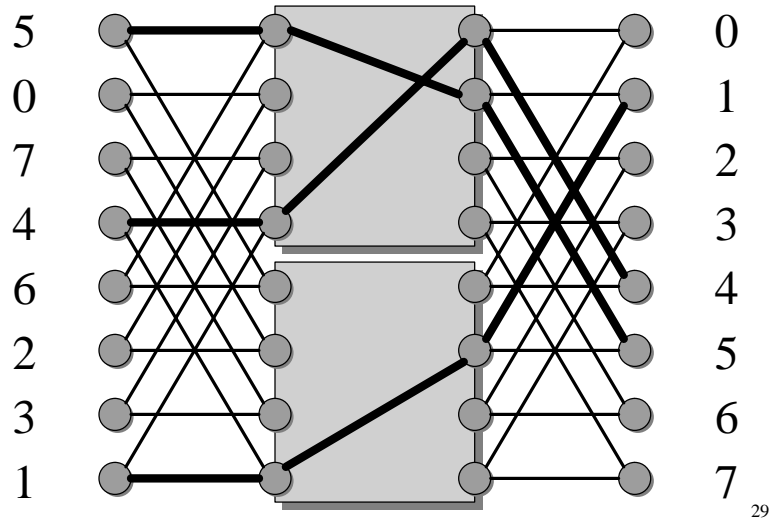

29

## Routing on a Beneš Network

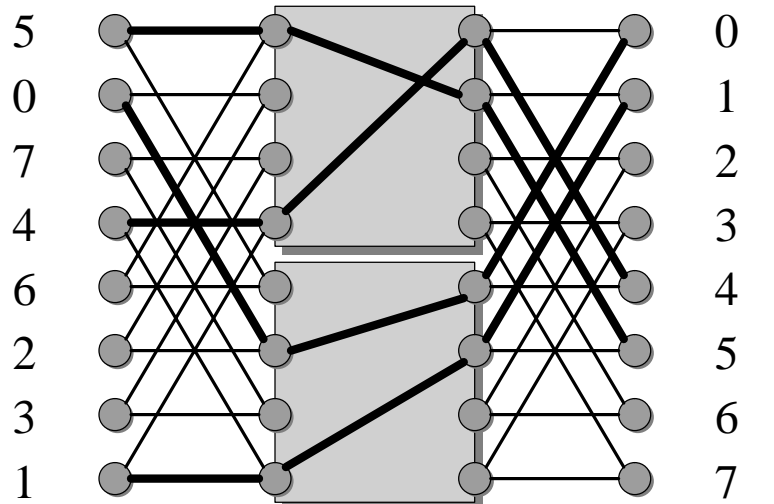

30

## Routing on a Beneš Network

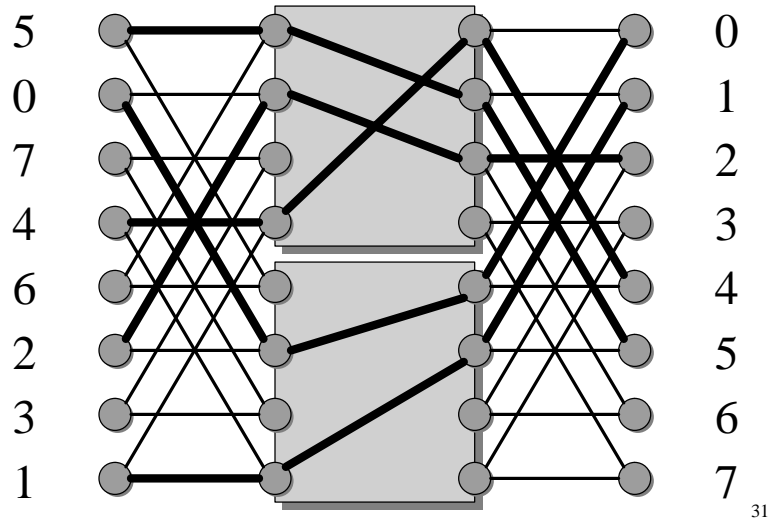

31

## Routing on a Beneš Network

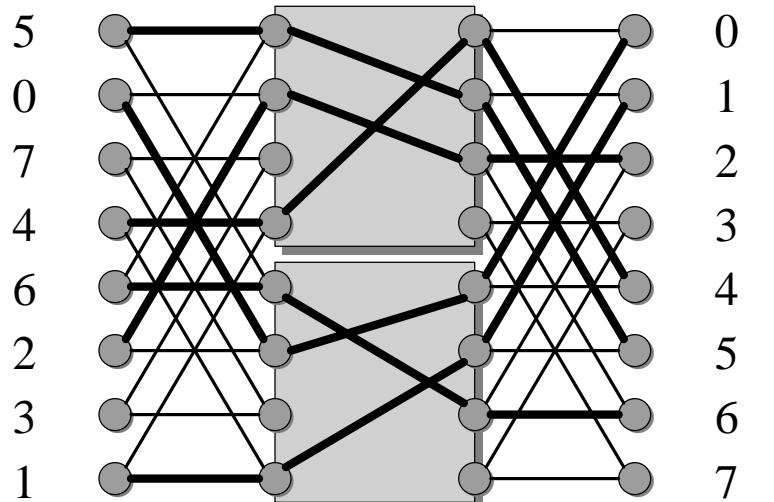

32



## Routing on a Beneš Network

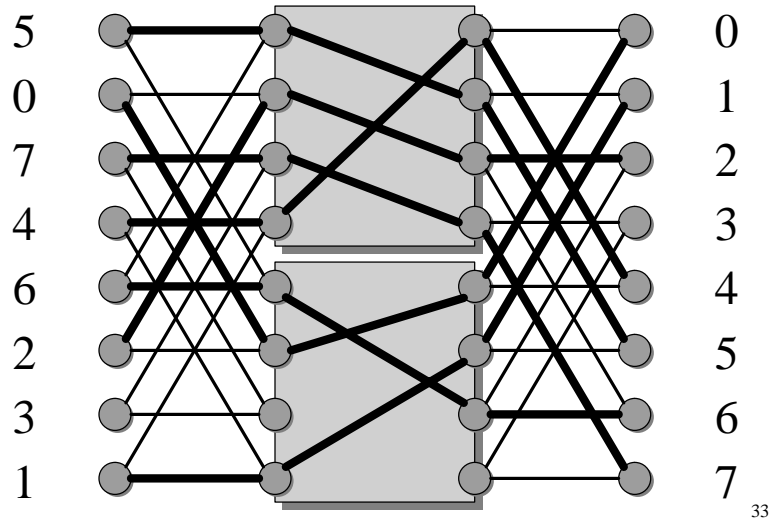

## Routing on a Beneš Network

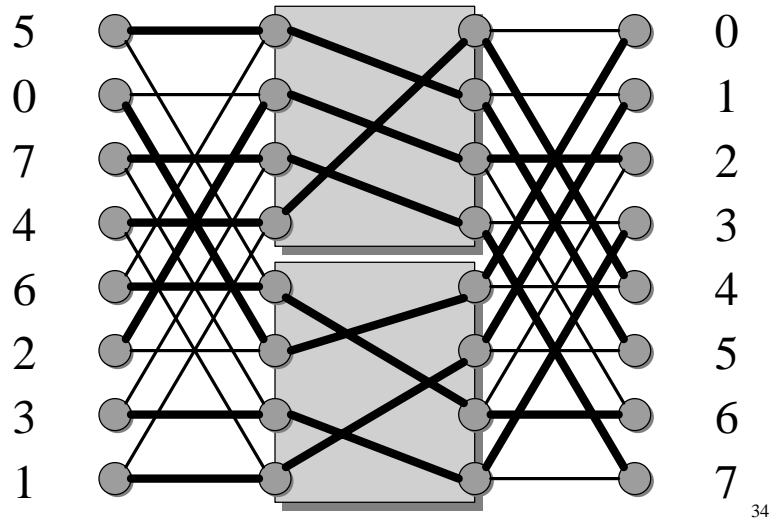

## Routing on a Beneš Network

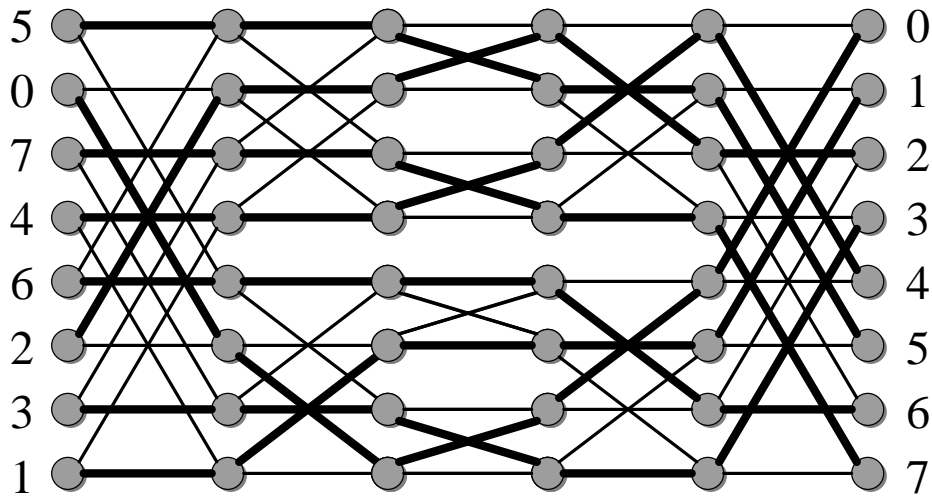

35